



Cam action
door closer system

DORMA TS 93

DORMA TS 93 – Cam action door closer system



More compact, lighter and more elegant

DORMA has set new standards with its TS 93 cam-action door closer system. Offering further technical refinements and enhanced sophistication, it constitutes an even more impressive specification – thanks to

- smaller dimensions
- concealed fixings
- height-adjustable standard (N) slide channel
- 30 mm high EMF, EMR and GSR slide channels
- mechanically secured cover
- delayed action feature as standard
- simple, fast installation
- low weight

Rapidly decreasing opening force

Unlike rack and pinion slide-channel door closers, the DORMA TS 93 system with its the linear drive mechanism and heart-shaped cam ensures that the resistance encountered when opening the door decreases almost instantly with the opening action. So even children, the elderly and handicapped people have no problem in opening the door.



Further information, specification texts

Additional information e.g. specification texts, drawings, installation instructions on many products can be accessed via electronic media (Internet, CD ROM, floppy disk). The codes beside the computer symbol  are the search terms. The specification texts are also available in printed form.

Contents	
Features and functions	Page 4
DORMA TS 93 B Door closer for pull-side door leaf fixing/ push-side transom fixing	6
DORMA TS 93 G Door closer for push-side door leaf fixing/ pull-side transom fixing	7
DORMA G 93 N Standard slide channel design	8
DORMA RF Hold-open unit	8
DORMA G 93 EMF Slide channel with electro-mechanical hold-open	10
DORMA G 93 EMR Slide channel with electro-mechanical hold-open and integral smoke detector	12
DORMA G 93 GSR Door co-ordinator slide channel for pull-side fixing	14
DORMA G 93 GSR-EMF Door co-ordinator slide channel with integral electro-mechanical hold-open for pull-side fixing	15
DORMA G 93 GSR/BG Door co-ordinator slide channel for push-side fixing	18
DORMA G 93 GSR-EMF/BG Door co-ordinator slide channel with integral electro-mechanical hold-open for push-side fixing	19
DORMA RMZ-K/S, DORMA RM Frame-mounted and ceiling-mounted smoke detectors	22
Accessories	24
Hold-open systems Regulations and information	27
Range of equipment and optional accessories Single doors	28
Range of equipment and optional accessories Double doors	30

Force profile
DORMA TS 93
(Spring strength: EN 5)
— Opening force
— Closing force

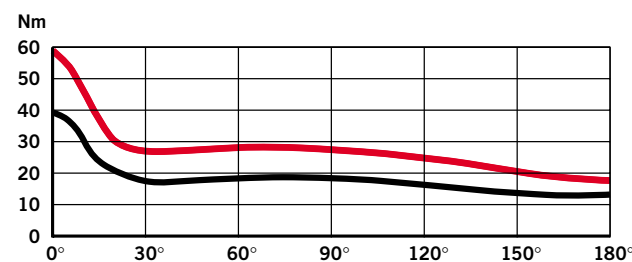

For every door and application – the best in aesthetics and function

With its TS 93, DORMA has developed an aesthetically elegant generation of door closers offering unbeatable ease of use. The TS 93 series comprises a modular system which enables just a few door closer models to be combined with a number of different slide channels to meet virtually every conceivable functional requirement. Doors of varying designs can be equipped for a wide range of different applications.

Advanced, computer-aided design and manufacturing with comprehensive quality assurance provide a secure basis for the outstanding reliability and long service life of this product.



Plus points...

... for the trade

- Low inventory costs and reduced stocking requirements thanks to streamlined modular system and separate packaging of closer body and slide channel assemblies.
- Practical solutions to satisfy special requirements and fixing situations.

... for the installer

- Suitable for all fixing positions.
- Universal fixing hole pattern for perfect alignment every time.
- Same fixing hole pattern for both clockwise-closing (ISO 5) and anticlockwise-closing (ISO 6) doors.
- Simple spring strength adjustment – in just a matter of seconds with a ratchet wrench.

... for the specifier/architect

- Harmony and compatibility with the architectural environment.
- All models feature the same, fully matching "Softline" styling.
- Available in a wide range of colours and finishes.

... for the user

- The perfect combination of aesthetic elegance, technical refinement and affordability.
- Wide spectrum of user-friendly and safety functions.
- Easy opening action, fully controlled closing.

Data and features		TS 93 B/G ¹⁾	
		EN 2-5	EN 5-7
Variable closing force	Spring strength		
Standard doors ²⁾	Up to 1250 mm Up to 1600 mm	● –	– ●
External doors, outward opening ²⁾	Up to 1250 mm Up to 1600 mm	● –	– ●
To EN 1154 A, for fire and smoke doors ²⁾	Up to 1250 mm Up to 1600 mm	● –	– ●
Non-handed		●	●
Arm assembly type	Standard	–	–
	Slide channel	●	●
Closing force variable by means of adjustment screw		●	●
Closing speed adjustable by valve		●	●
Latching speed adjustable	at arm	–	–
	at valve	●	●
Backcheck (BC/ÖD)	self-adjusting	–	–
	adjustable at valve	●	●
Delayed action (DC/SV) adjustable at valve		●	●
Hold-open		○	○
Weight in kg		3.5	5.2
Dimensions in mm	Length (L)	275	285
	Overall depth (B)	53	62
	Height (H)	60	71

● yes – no ○ option

¹⁾ B = Standard model for pull-side door leaf fixing/push-side transom fixing

G = Special model for push-side door leaf fixing/pull-side transom fixing.

²⁾ For applications involving particularly heavy or wide doors, and doors which have to close against wind resistance, the next highest door closer size should be selected, or the closing force adjusted to a higher setting.

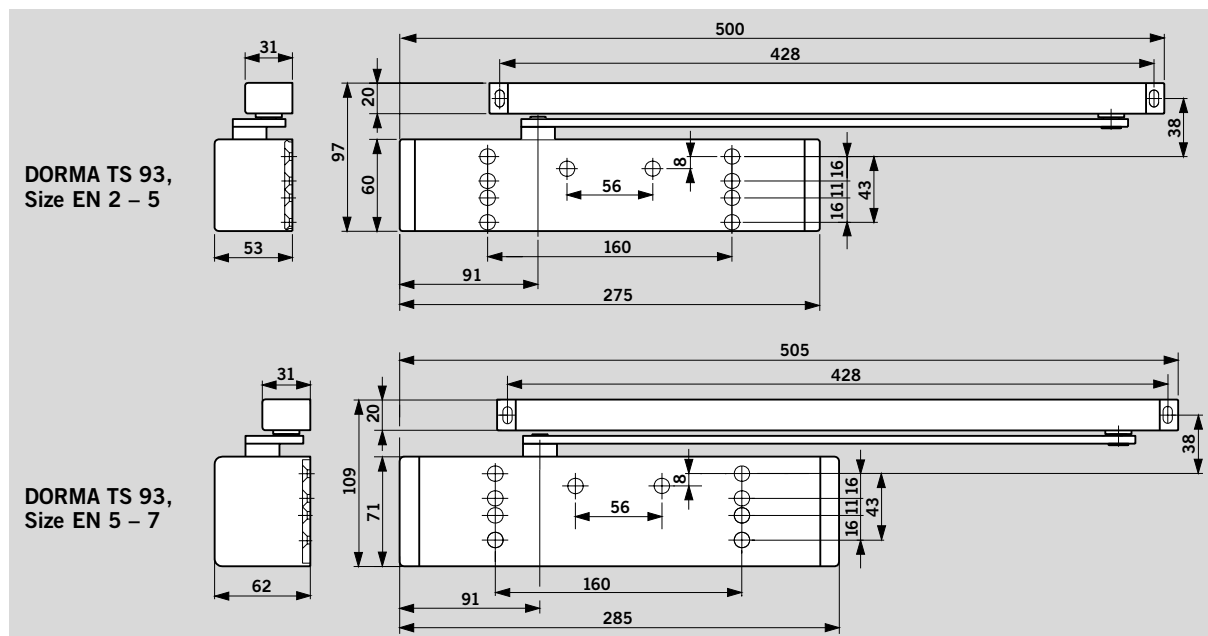

Standard mounting backplate with universal fixing hole system

This mounting backplate with its universal hole system, including hole pattern to supplementary sheet 1 of DIN EN 1154 A, ensures ideal fixing whatever the conditions and irrespective of the door type. The fixing hole patterns are the same for both sizes of the DORMA TS 93. Additional mounting plates/brackets are no longer required. Alignment dowels on the mounting backplate facilitate location of the closer body.

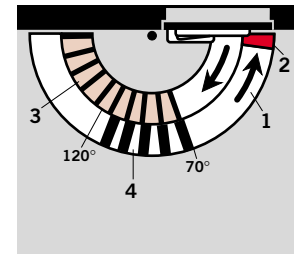
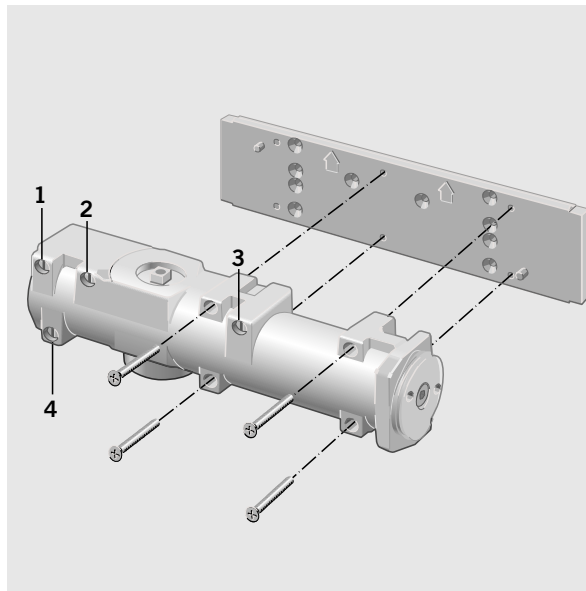

- 1 Fully controlled closing action with adjustable speed
- 2 Adjustable latch speed
- 3 Adjustable backcheck
- 4 Adjustable delayed action

Backcheck

The backcheck feature ensures the safe deceleration and restraint of a door which has been flung open or caught by a gust of wind. This effectively reduces the danger of the door and adjacent wall being damaged.

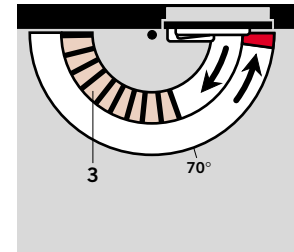

- 3 Adjustable backcheck

Delayed action

The delayed action feature retards the closing cycle between 120° and 70° (approximate values for pull-side door leaf fixing). The extra time allowed for passage through the doorway can be essential for people with luggage or bulky items: mothers with prams, personnel with tea trolleys, post trolleys, hospital beds, etc.; and also for disabled people.

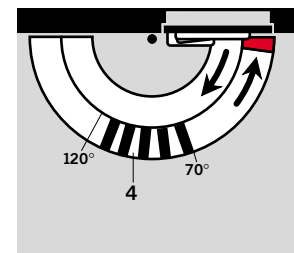
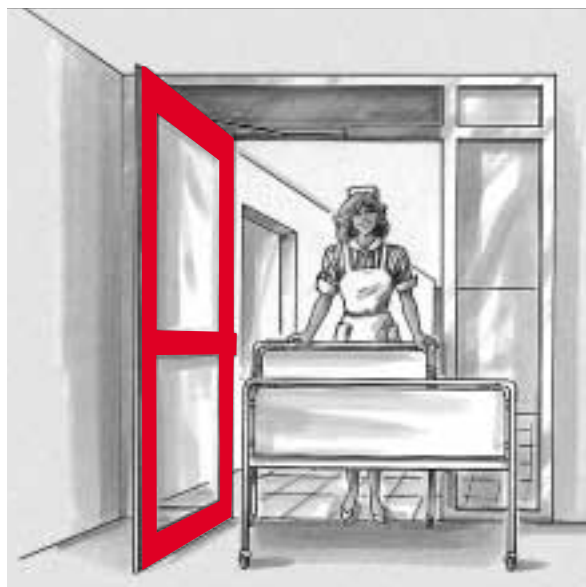

- 4 Adjustable delayed action

Pull-side door leaf fixing

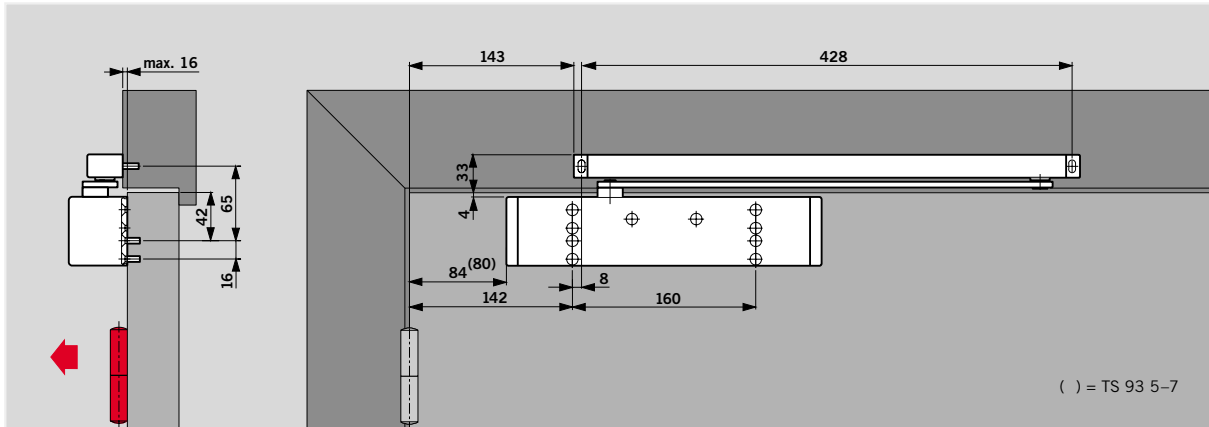

Door leaf fixing (standard arrangement) of the DORMA TS 93 B on the pull side. Structural conditions permitting, an opening angle of 180° is possible with this fixing method. In most cases, a wall recess may have to be provided for the door closer. Example: Anticlockwise-closing (ISO 6) door; mirrored arrangements apply to clockwise-closing (ISO 5) doors.

F Approval certification

The DORMA TS 93 B is CERTIFIRE approved (Certificate No. CF 119) for door types ITT 120.



Specification text

Cam-action overhead door closer tested to EN 1154, CERTIFIRE approved, Softline design, with rapidly decreasing opening torque/force. Closing speed, latching speed, backcheck and delayed action adjustable at the valve. Mounting backplate with universal fixing hole pattern. Non-handed, with slide channel... (see pages 8 – 21)

Model

for pull-side door leaf fixing

Size

EN 2 – 5
 EN 5 – 7

Colour

silver dark brown white, like RAL 9010 9016
 stainless steel
 polished brass
 special colour_(like RAL_)

Make DORMA TS 93 B

 TS93N/2-5
TS93N/5-7

Push side door leaf fixing

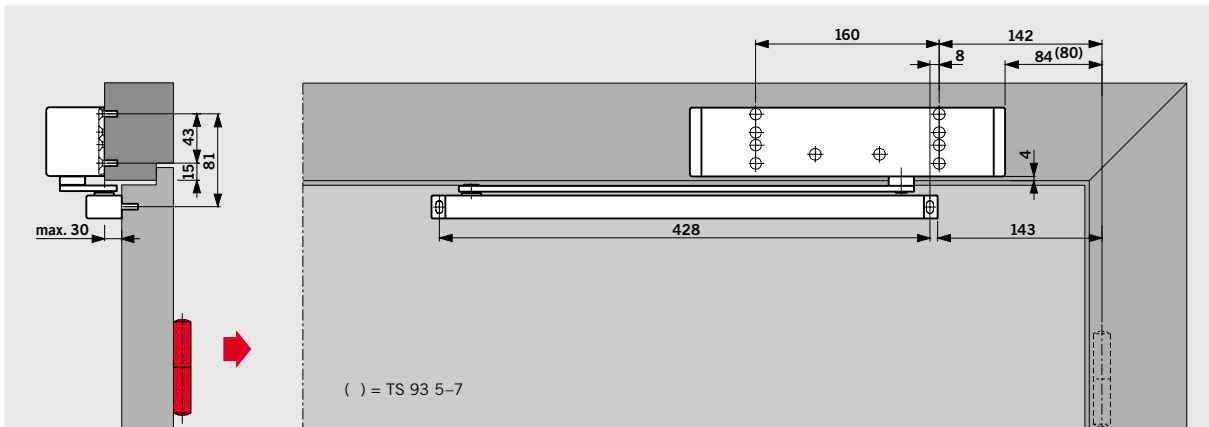

Transom fixing (overhead frame fixing) of the DORMA TS 93 B on the push side. Backcheck and delayed action non-operative with this fixing arrangement. The door opening angle is limited to approx. 120° to 145°, depending on the structural conditions. In order to prevent damage to the wall and door, a door stop should be installed to limit the maximum angle of door opening. Example: Anticlockwise-closing (ISO 6) door; mirrored arrangements apply to clockwise-closing (ISO 5) doors.

F Approval certification

The DORMA TS 93 B is CERTIFIRE approved (Certificate No. CF 119) for door types ITT 120.



Specification text

Cam-action overhead door closer tested to EN 1154, CERTIFIRE approved, Softline design, with rapidly decreasing opening torque/force. Closing speed and latching speed adjustable at the valve. Mounting backplate with universal fixing hole system. Non-handed, with slide channel... (see pages 8 – 21).

Model

for push-side transom fixing

Size

EN 2 – 5
 EN 5 – 7

Colour

silver dark brown white, like RAL 9010 9016
 stainless steel
 polished brass
 special colour_(like RAL_)

Make DORMA TS 93 B

 TS93N/2-5
TS93N/5-7

Push-side door leaf fixing

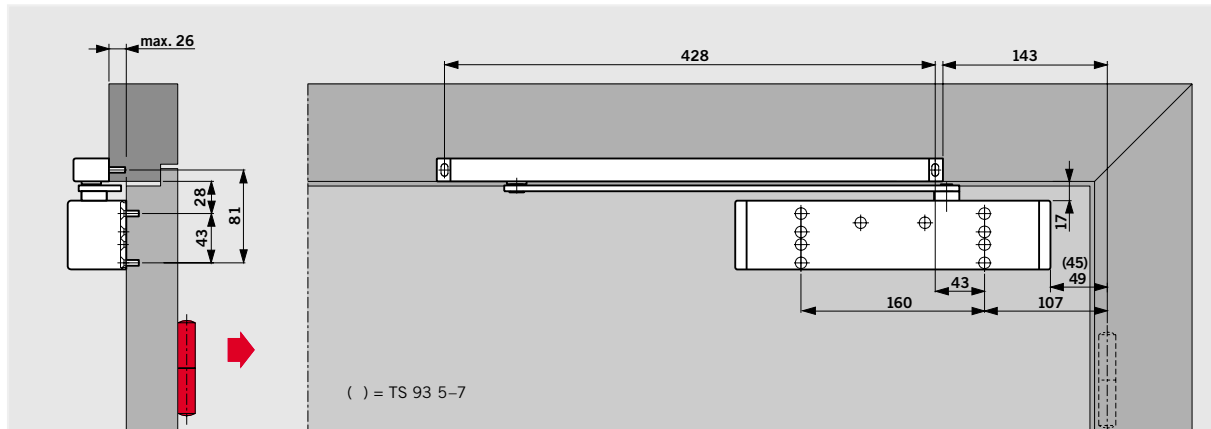

Door leaf fixing (standard installation) of the DORMA TS 93 G on the push side. The door opening angle is limited to approx. 120° to 145°, depending on the structural conditions. In order to prevent damage to the wall and door, a door stop should be installed to limit the maximum angle of door opening.

A door stop must be installed for fire and smoke doors.

Example: Anticlockwise-closing (ISO 6) door; mirrored arrangements apply to clockwise-closing (ISO 5) doors.

F Approval certification

The DORMA TS 93 B is CERTIFIRE approved (Certificate No. CF 119) for door types ITT 120.



Specification text

Cam-action overhead door closer tested to EN 1154, CERTIFIRE approved, Softline design, with rapidly decreasing opening torque/force. Closing speed, latching speed, backcheck and delayed action adjustable at the valve. Mounting backplate with universal fixing hole system. Non-handed, with slide channel... (see pages 8 – 21)

Model

for push-side door leaf fixing

Size

EN 2 – 5
 EN 5 – 7

Colour

silver dark brown white, like RAL 9010 9016
 stainless steel
 polished brass
 special colour_(like RAL_)

Make DORMA TS 93 G

 TS93G/N/2-5
TS93G/N/5-7

Pull-side transom fixing

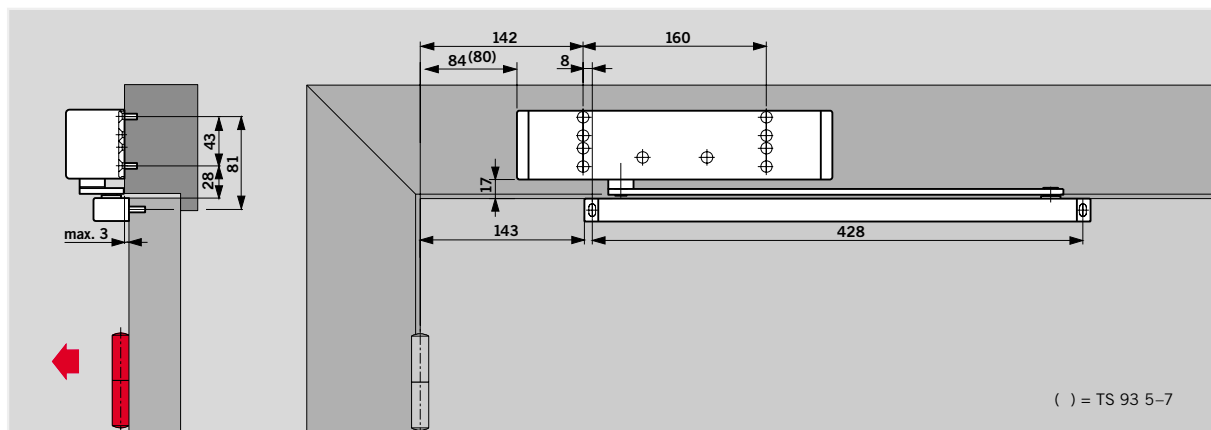

Transom fixing (overhead frame fixing) of the DORMA TS 93 G on the pull side. Structural conditions permitting, an opening angle of 180° is possible with this fixing method. Example: Anticlockwise-closing (ISO 6) door; mirrored arrangements apply to clockwise-closing (ISO 5) doors.

F Approval certification

The DORMA TS 93 B is CERTIFIRE approved (Certificate No. CF 119) for door types ITT 120.



Specification text

Cam-action overhead door closer tested to EN 1154, CERTIFIRE approved, Softline design, with rapidly decreasing opening torque/force. Closing speed, latching speed, backcheck and delayed action adjustable at the valve. Mounting backplate with universal fixing hole system. Non-handed, with slide channel... (see pages 8 – 21)

Model

for pull-side transom fixing

Size

EN 2 – 5
 EN 5 – 7

Colour

silver dark brown white, like RAL 9010 9016
 stainless steel
 polished brass
 special colour_(like RAL_)

Make DORMA TS 93 G

 TS93G/N/2-5
TS93G/N/5-7

Standard model

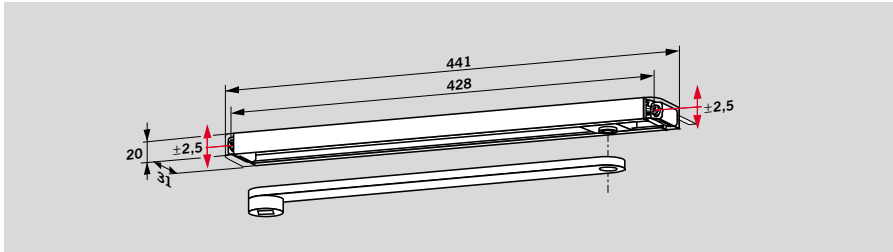

The **DORMA G 93 N** slide channel assembly incorporates the slide arm, slide channel, slide block, fixing adapters, screws and end caps. The DORMA G 93 N slide channel assembly is non-handed and can be combined with all door closer models.

Thanks to oblong holes in the fixing adapters, the slide channel can be effectively adjusted to variations in the drill hole pattern while keeping the gap between door closer body and slide channel aligned and parallel.

F Approval certification

The DORMA G 93 N has been successfully type-tested to EN 1154 in conjunction with the DORMA TS 93. Certificates are available on request.

Specification text

DORMA TS 93 ... door closer (see pages 6 and 7) with slide channel G 93 N, standard model.

Colour

silver dark brown
 white, like RAL 9010 9016
 stainless steel
 polished chrome
 polished brass
 special colour_(like RAL_)

Make DORMA TS 93 N

TS93N/2-5
 TS93N/5-7
 TS93G/N/2-5
 TS93G/N/5-7

Hold-open unit

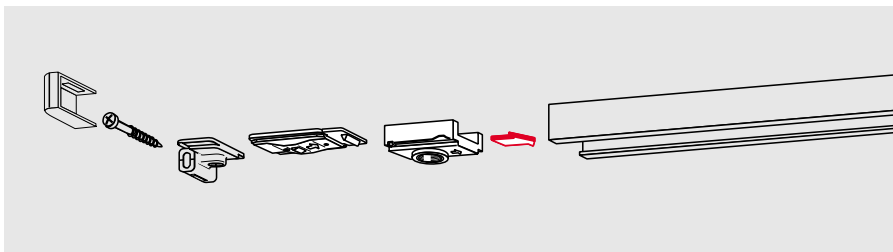

The **DORMA RF** hold-open unit enables doors to be securely held without any fall-back at precisely the required position up to an opening angle of approx. 150°. The hold-open function can be easily switched on and off by the user, and

the release force can be adjusted to the door type concerned. The DORMA RF mechanism is non-handed and has been specifically designed for retrofitting to the N type standard slide channel.

The suitability of the hold-open unit may be limited where the closer unit is fixed to the door leaf on the push side, in combination with outward-opening doors, and also in the case of large, heavy doors.

Not for fire and smoke doors.

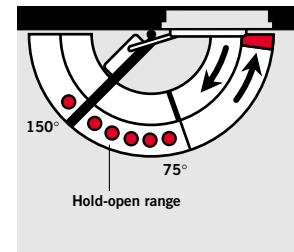

Accessories

DORMA RF hold-open unit

TS93RF/2-5
 TS93G/RF/2-5

Cushioned limit stay

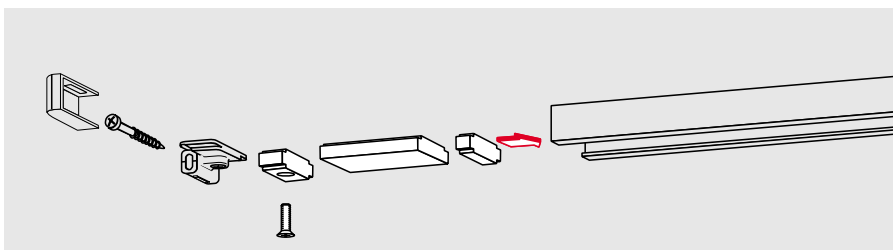

Accessories for the DORMA G 93 N, RF slide channel: **Cushioned limit stay** for retrofitting to the slide channel. Adjustable between 80° and **max. 120°**.

The cushioned limit stay prevents the door from hitting the adjacent wall when opened normally.

The cushioned limit stay is not a heavy-duty protective device and in many applications cannot substitute for a door stop.

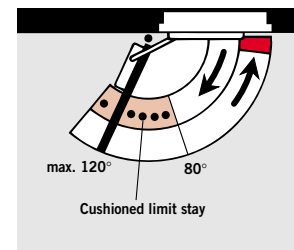

Accessories

Cushioned limit stay

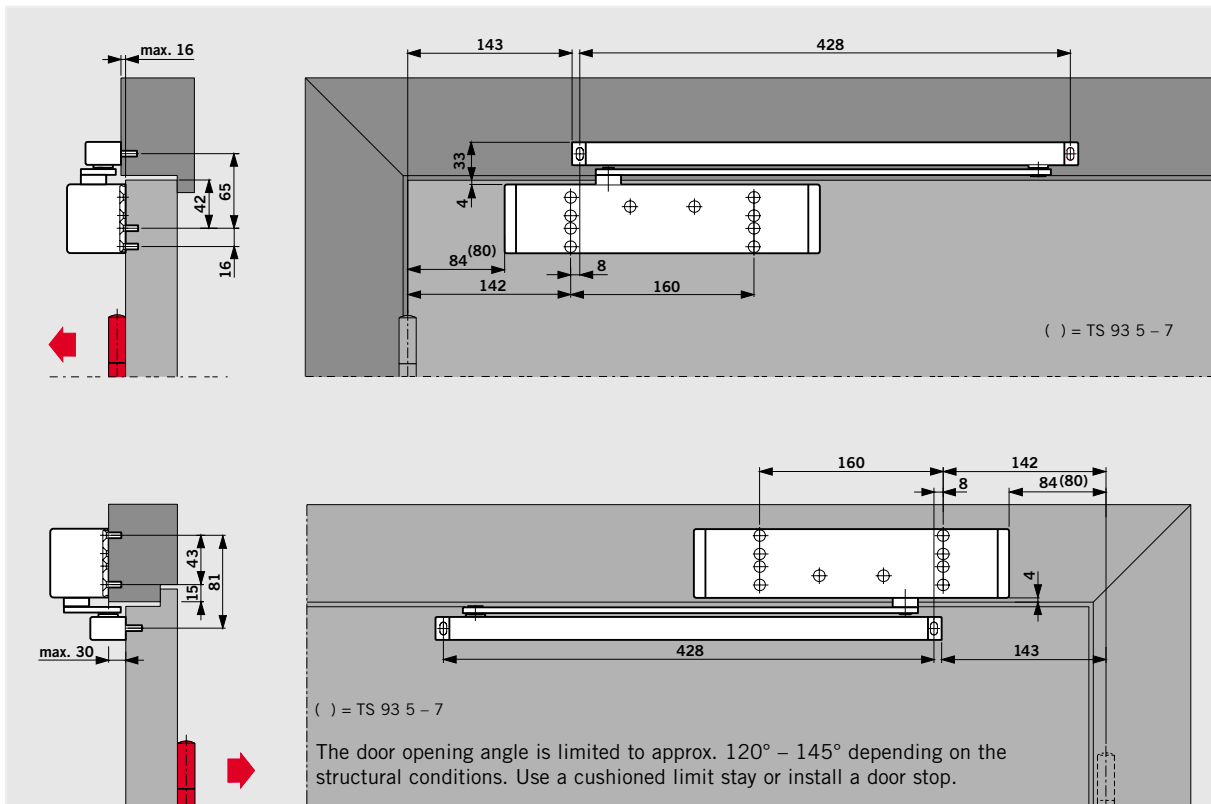

DORMA **TS 93 B** door closer with DORMA G 93 N slide channel assembly, door leaf fixing on the pull side and transom fixing on the push side.
 Examples: Anticlockwise-closing (ISO 6) door; mirrored arrangements apply to clockwise-closing (ISO 5) doors.

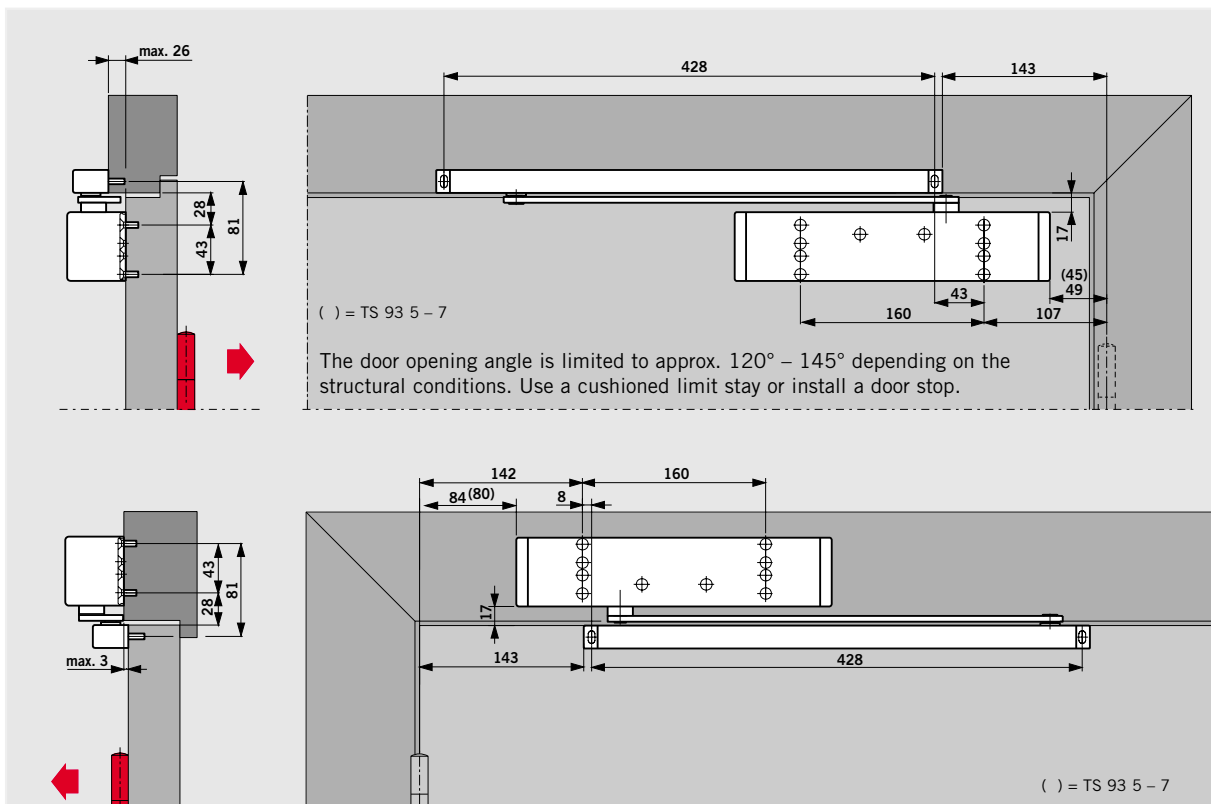

DORMA **TS 93 G** door closer with DORMA G 93 N slide channel assembly, door leaf fixing on the push side and transom fixing on the pull side.
 Examples: Anticlockwise-closing (ISO 6) door; mirrored arrangements apply to clockwise-closing (ISO 5) doors.

Electro-mechanical hold-open

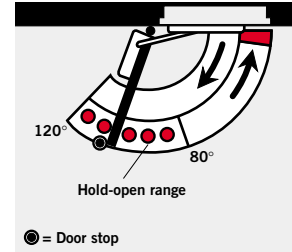
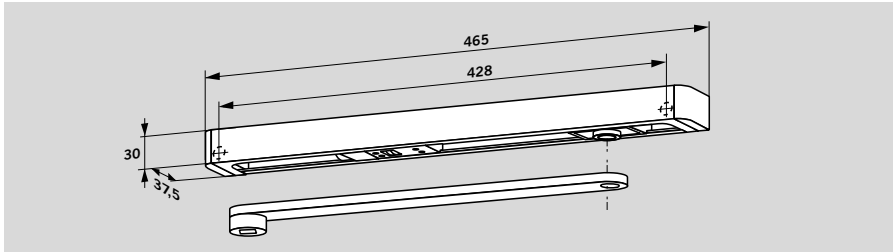

The **DORMA G 93 EMF** slide channel assembly enables the door to be held open securely at a preselected position without fall-back. The hold-open point can be adjusted within an opening angle of approx. 80° and 120°.

Note

The active leaf can be opened up to the maximum selected hold-open point (door stop to be positioned accordingly).

In the event of an alarm or a fault in the power supply, the hold-open is released and the door is closed by the door closer. The release is triggered by a signal from external smoke detectors (e.g. DORMA RMZ-K/S or DORMA RM).

The release force for the hold-open mechanism can be adjusted without tools and is rated to ensure that the door can also be easily released manually.

The DORMA G 93 EMF slide channel assembly comprises the slide arm, slide channel, slide block, electro-mechanical hold-open unit, cover, fixing screws and end caps. The DORMA G 93 EMF is transom-fixed and non-handed.

In the case of particularly large and heavy doors (over 1250 mm), or doors in which the hold-open point required exceeds 120°, we recommend that DORMA EM hold-open magnets in conjunction with the DORMA RMZ-K/S central smoke detector be employed instead of the electro-mechanical hold-open unit.

Technical data

Operating voltage	24 vDC, ± 15 %
Power input	1.4 W
Rated for continuous duty	(100 %)
Release force	adjustable

F Approval certification

The DORMA TS 93 EMF has been successfully type-tested to EN 1155, Electrically Powered Hold-Open Devices. Certificates are available on request.

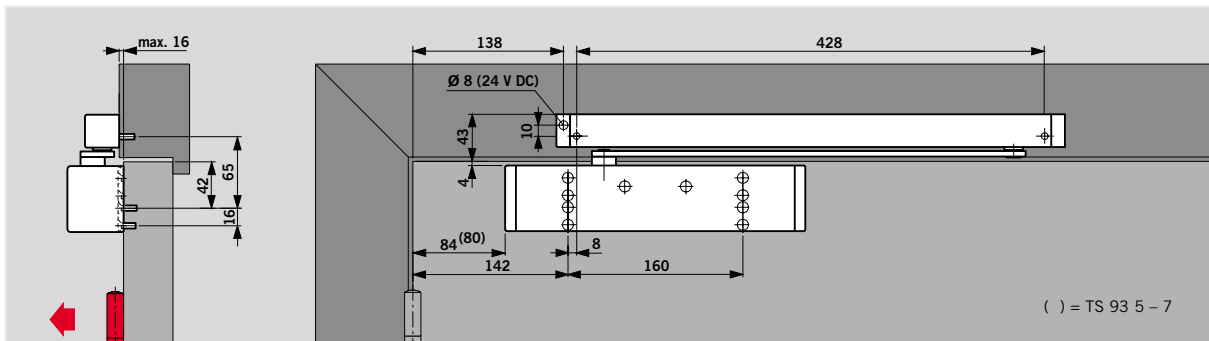

DORMA **TS 93 B** closer with DORMA G 93 EMF slide channel assembly, pull-side fixing
Example: Anticlockwise-closing (ISO 6) door; mirrored arrangements apply to clockwise-closing (ISO 5) doors.

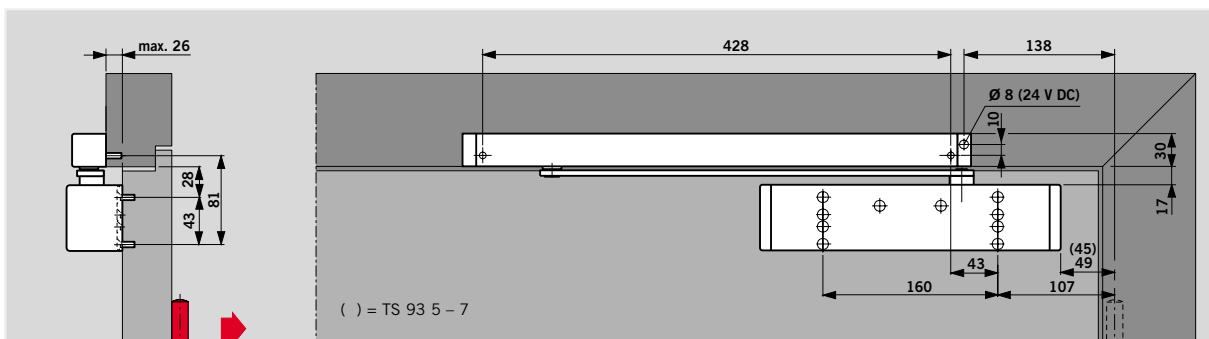

DORMA **TS 93 G** closer with DORMA G 93 EMF slide channel assembly, push-side fixing
Example: Anticlockwise-closing (ISO 6) door; mirrored arrangements apply to clockwise-closing (ISO 5) doors.

Specification text

DORMA TS 93 ... door closer (see pages 6 and 7) G 93 EMF slide channel assembly, with integrated 24 vDC electro-mechanical hold-open, tested to EN 1155. Hold-open point (80° – 120°) and release force adjustable.

Colour

- silver dark brown
- white, like RAL 9010 9016
- stainless steel
- polished brass
- special colour_(like RAL_)

Make DORMA TS 93 EMF

- TS93EMF/2-5
- TS93G/EMF/2-5

Example application

Hold-open system on a fire and smoke door, comprising: DORMA TS 93 B door closer, DORMA G 93 EMF slide channel assembly, DORMA RMZ-K (smoke sensor, release switching unit and stabilised power pack for 24 vDC) as frame-mounted smoke detector, plus one DORMA RM smoke detector on both sides of the door. (See also page 22.)

Regulations/Information

The use of hold-open devices may be subject to certain conditions – see page 27.

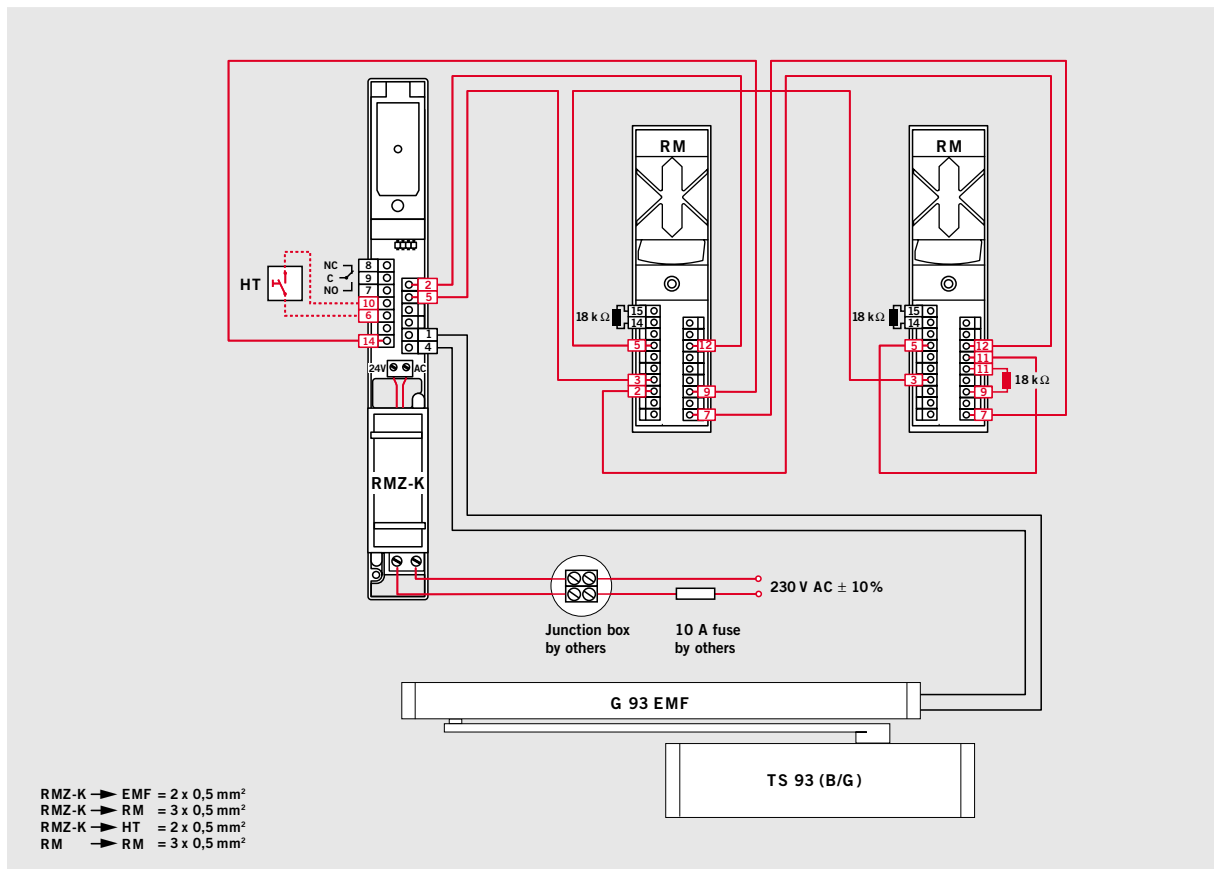
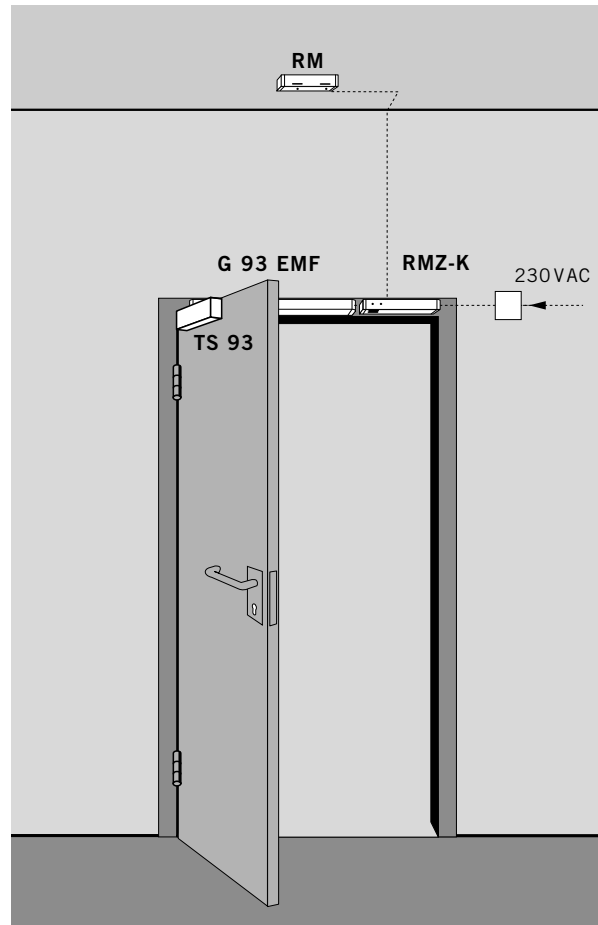

Electro-mechanical hold-open and integral smoke detector

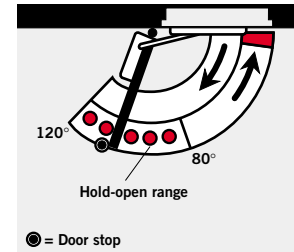
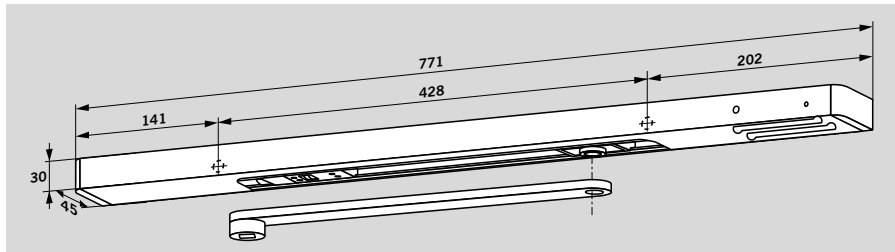

The **DORMA G 93 EMR** slide channel assembly enables fire and smoke doors to be held open securely at precisely the angle required, and monitored and controlled completely independently of other systems. The hold-open point can be adjusted to opening angles between approx. 80° and 120°.

Note

The active leaf can be opened up to the maximum selected

hold-open point (door stop to be positioned accordingly). In the event of an alarm or a fault in the power supply, the hold-open is released and the door is closed by the door closer.

The release force for the hold-open mechanism can be adjusted without tools and is rated to ensure that the door can also be easily released manually.

The **DORMA G 93 EMR** slide channel assembly comprises the slide arm, slide channel, slide block, electro-mechanical hold-open unit, smoke detector, power pack, cover, fixing screws and end caps. The **DORMA G 93 EMR** is non-handed and is available as an **Easy-action** or **Standard** model.

Both models offer the option of fitting additional detectors (RMZ-S – only available as a two-wire system). An additional manual release mechanism can be fitted to the Easy-action model, and a volt-free changeover contact is also optionally available. In the case of particularly large and heavy doors (over 1250 mm), or doors in

which the hold-open point required exceeds 120°, we recommend that **DORMA EM** hold-open magnets be employed instead of the electro-mechanical hold-open unit, in conjunction with the **DORMA RMZ-K/S** frame-mounted smoke detector.

F Approval certification

The **DORMA TS 93 EMR** has been successfully type-tested to EN 1155, Electrically Powered Hold-Open Devices. Certificates are available on request.

Technical data

Power supply	230 vAC, ± 10%
Operating voltage (internal)	24 vDC
Max. output rating	4.4 W
Rated for continuous duty	100%
Release torque/force	adjustable

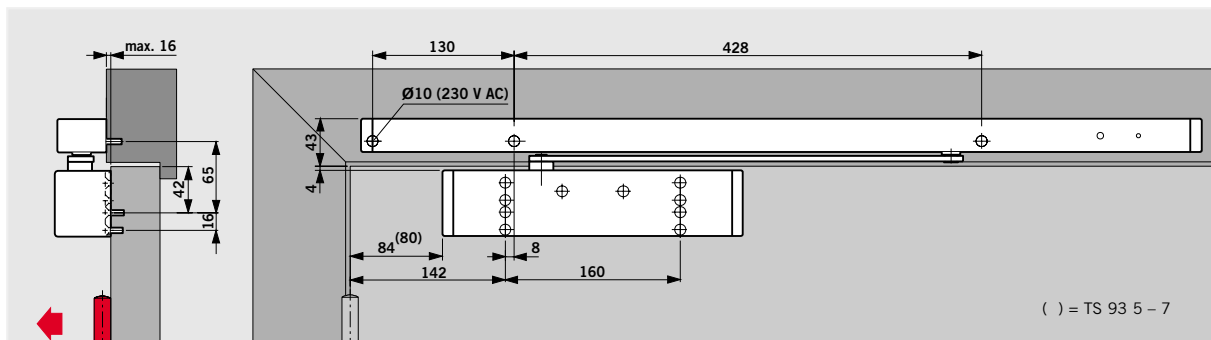

DORMA TS 93 B closer with **DORMA G 93 EMR** slide channel assembly, pull-side fixing
Example: Anticlockwise-closing (ISO 6) door; mirrored arrangements apply to clockwise-closing (ISO 5) doors.

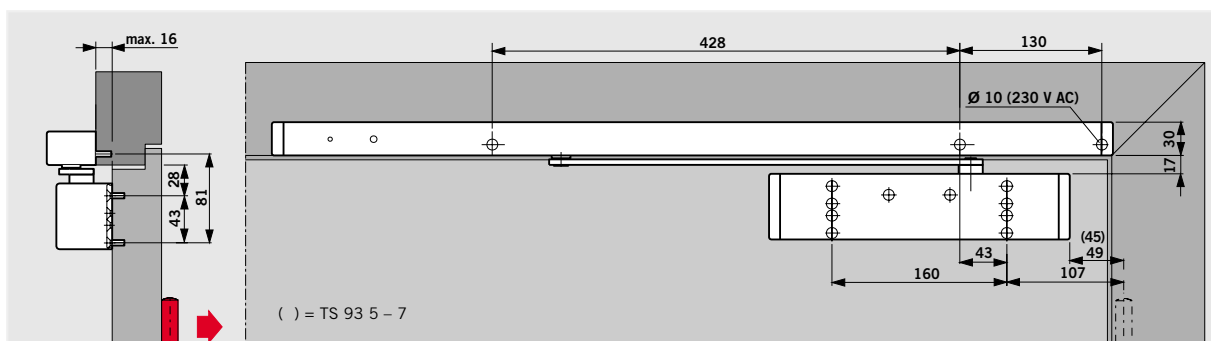

DORMA TS 93 G door closer with **DORMA G 93 EMR** slide channel assembly, push-side fixing
Example: Anticlockwise-closing (ISO 6) door; mirrored arrangements apply to clockwise-closing (ISO 5) doors.

Specification text

DORMA TS 93 ... door closer (see pages 6 and 7) G 93 EMR slide channel assembly, with integrated electro-mechanical hold-open (tested to EN 1155), power pack, smoke detector and one-piece cover. Hold-open point (80° – 120°) and release force adjustable. Power supply 230 vAC Operating voltage 24 vDC

Colour

- silver dark brown white, like RAL 9010 9016
- stainless steel
- polished brass
- special colour_(like RAL_)

Model

- Easy-action model with optional fitting of additional detectors, external manual release and volt-free alarm contact.

Make DORMA TS 93 EMR-K

- Standard model with optional fitting of two additional two-wire detectors

Make DORMA TS 93 EMR-S

Example application

Hold-open system on a fire and smoke door, comprising: DORMA TS 93 B door closer, DORMA G 93 EMR slide channel assembly, plus one DORMA RM smoke detector on both sides of the door. (See also page 22.)

Regulations/Information

The use of hold-open devices may be subject to certain conditions – see page 27.

- TS93EMR/K/2-5
- TS93EMR/S/2-5
- TS93EMR/K/G/2-5
- TS93EMR/S/G/2-5

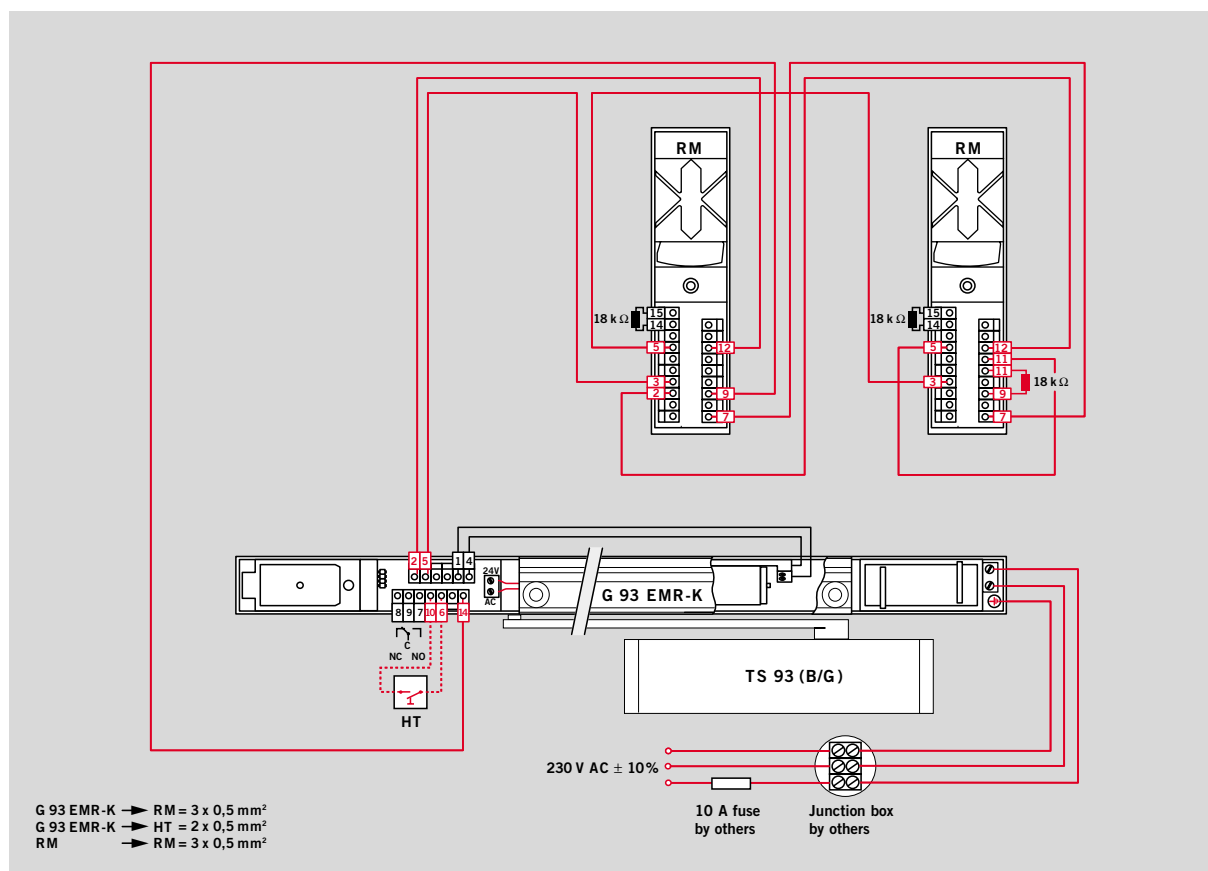
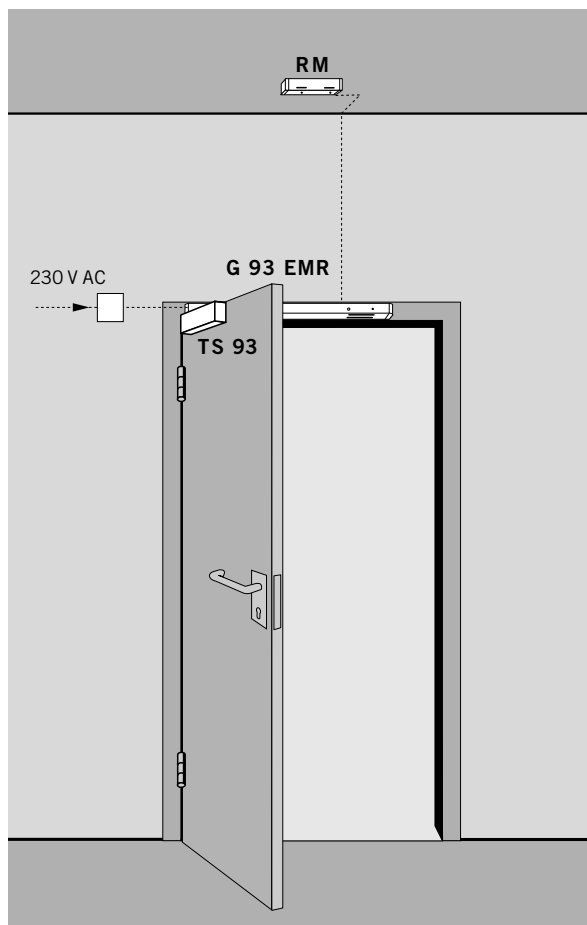

For pull-side fixing

The DORMA G 93 GSR slide channel with integral door co-ordinator for **double doors** ensures that the active leaf always closes after the inactive leaf.

A slide channel with an integral door co-ordinator of this system design always consists of an active leaf slide channel, an inactive leaf slide channel and a set of covers.

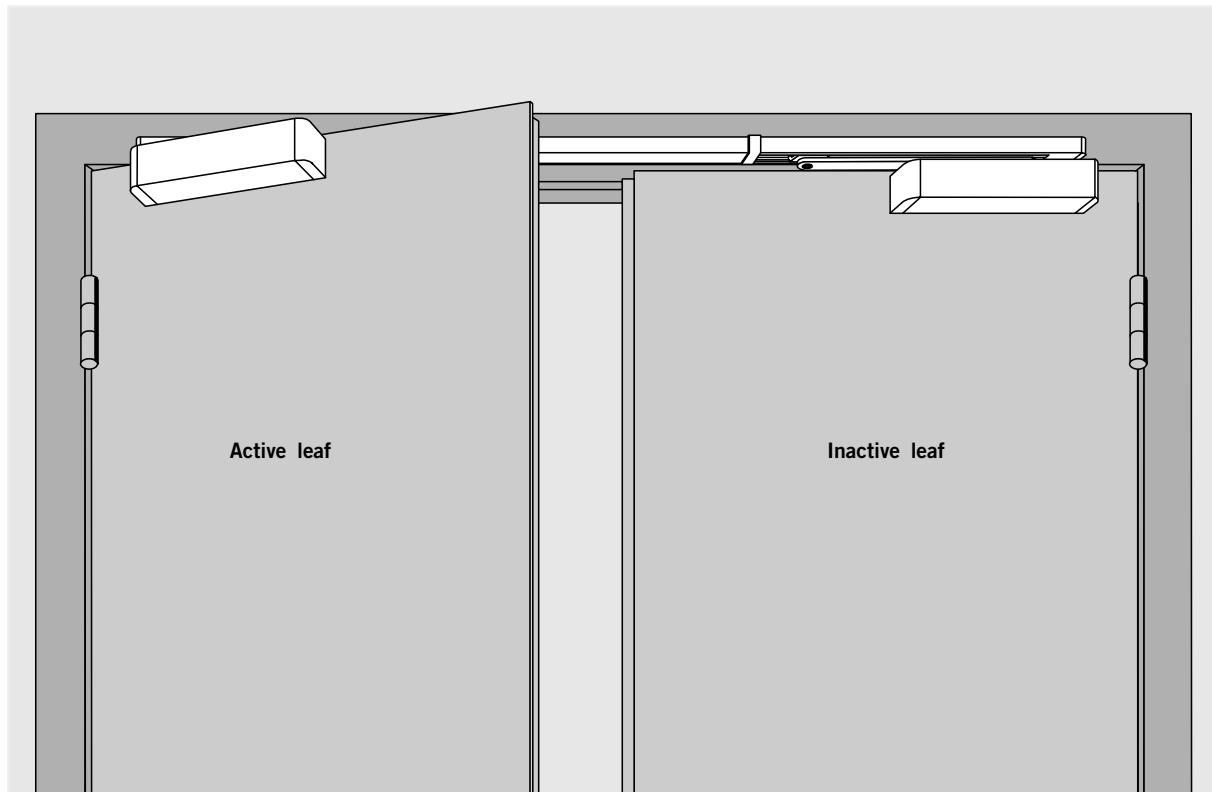

DORMA G 93 GSR

The DORMA G 93 GSR door co-ordinator slide channel features a push rod clamping system. As this system operates independently of the door closer hydraulics, it offers maximum safety and reliability (doors prevented from "creeping closed"). An overload release protects both the door co-ordinator and the door set from damage. The DORMA G 93 GSR door co-ordinator is non-handed and can be combined with DORMA TS 93 B door closers.

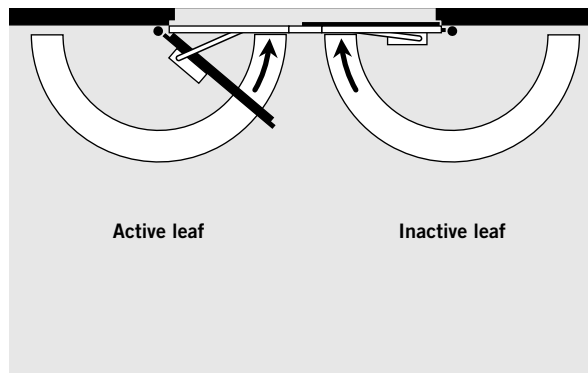

Specification text

DORMA TS 93 B door closer (see page 6) with G 93 GSR slide channel, with integral mechanical door co-ordinator employing a push rod clamping system with overload release which operates independently of the closer hydraulics. With single cover extending over the top of both door leaves.

Colour

- silver dark brown
- white,
- like RAL 9010 9016
- stainless steel
- polished brass
- special colour_(like RAL_)

Make DORMA TS 93 GSR

- TS93GSR/2-5
- TS93GSR/5-7

F Approval certification

The DORMA TS 93 GSR has been successfully type-tested to EN 1158, Door Co-ordinator Devices. Certificates are available on request.

With integral electro-mechanical hold-open, for pull-side fixing

These door co-ordinators not only ensure the correct closing sequence of double doors, but also allow the door leaves to be individually held open in various combinations depending on the slide channel type employed (see page 16). In the event of an alarm or a fault in the power supply,

the hold-open is released and the door is closed by the door closer. The release is triggered by a signal from external smoke detectors (e.g. DORMA RMZ-K/S or DORMA RM). The release force for the hold-open mechanism can be adjusted without tools and is rated to ensure that

the door can also be effortlessly released manually. DORMA G 93 GSR-EMF door co-ordinator slide channels are non-handed and are combined with DORMA TS 93 B door closers.

Specification text

DORMA TS 93 B door closer (see page 6) with G 93 GSR slide channel, with integral mechanical door co-ordinator employing a push rod clamping system with overload release, which operates independently of the closer hydraulics. With single cover extending over the top of both door leaves.

DORMA G 93 GSR-EMF 1

This door co-ordinator contains just one hold-open mechanism, located in the inactive leaf slide channel, for holding open both door leaves. The single-point hold-open position is adjustable between approx. 80° and 130°. **Note** The active leaf can be opened up to the maximum selected hold-open point (door stop to be positioned accordingly). The active leaf can be held open by the door co-ordinator at any angle up to max. 150°.

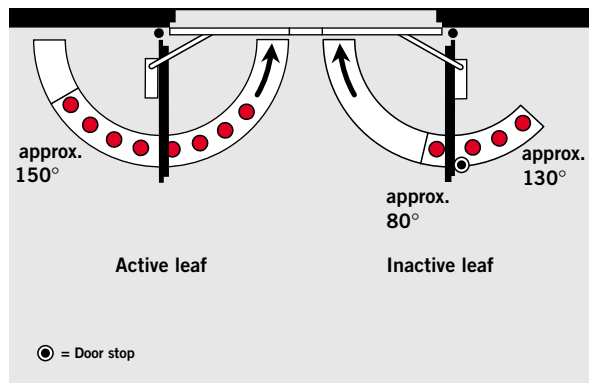

EMF 1

□ With integrated electro-mechanical hold-open for the inactive leaf, 24 vDC, tested to EN 1155. Hold-open point (80° – 130°) and release force adjustable.

Make

DORMA TS 93 GSR-EMF 1
 TS93GSR-EMF1/2-5

DORMA G 93 GSR-EMF 2

With this door co-ordinator, the active leaf can be held open independently of the inactive leaf. The hold-open points for each leaf lie between approx. 80° and 130°. **Note** The active leaf can be opened up to the maximum selected hold-open point (door stop to be positioned accordingly).

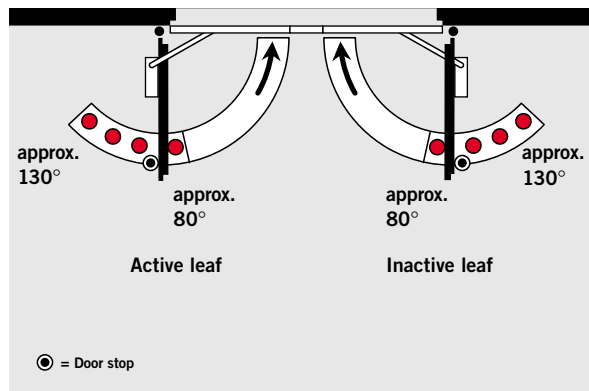

EMF 2

□ With integrated electro-mechanical hold-open for both leaves, 24 vDC, tested to EN 1155. Hold-open point (80° – 130°) and release force adjustable.

Make

DORMA TS 93 GSR-EMF 2
 TS93GSR-EMF2/2-5

DORMA G 93 GSR-EMF 1G

This door co-ordinator enables the active leaf to be held open independently in special door sets involving, for example, fixed side screens, narrow inactive leaves ("penny farthing" doors), etc. The hold-open point lies between approx. 80° and 130°. **Note** The active leaf can be opened up to the maximum selected hold-open point (door stop to be positioned accordingly).

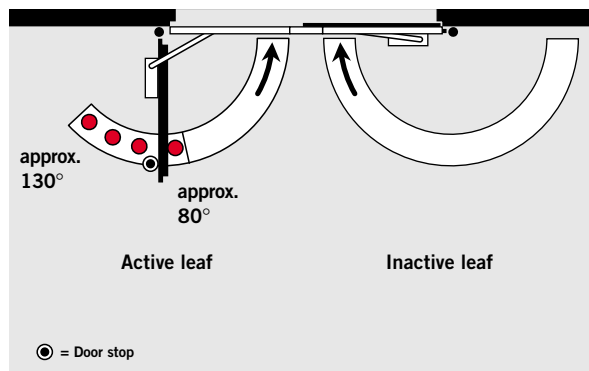

EMF 1G

□ With integrated electro-mechanical hold-open for the active leaf, 24 vDC, tested to EN 1155. Hold-open point (80° – 130°) and release force adjustable.

Make

DORMA TS 93 GSR-EMF 1G
 TS93GSR-EMF1G/2-5

F Approval certification

The DORMA TS 93 GSR-EMF 1, EMF 2 and EMF 1G have been successfully type-tested to EN 1155, Electrically Powered Hold-Open Devices. Certificates are available on request.

Technical data

Operating voltage	24 vDC ± 15 %
Power input	1.4 W (GSR EMF 2 = 2.8 W)
Rated for continuous duty	100 %
Release torque/force	adjustable

In the case of doors in which the hold-open point required exceeds 130°, we recommend that DORMA EM hold-open magnets be employed instead of the electro-mechanical hold-open unit.

Colour

□ silver □ dark brown white, like RAL □ 9010 □ 9016
 □ stainless steel
 □ polished brass
 □ special colour_(like RAL_)

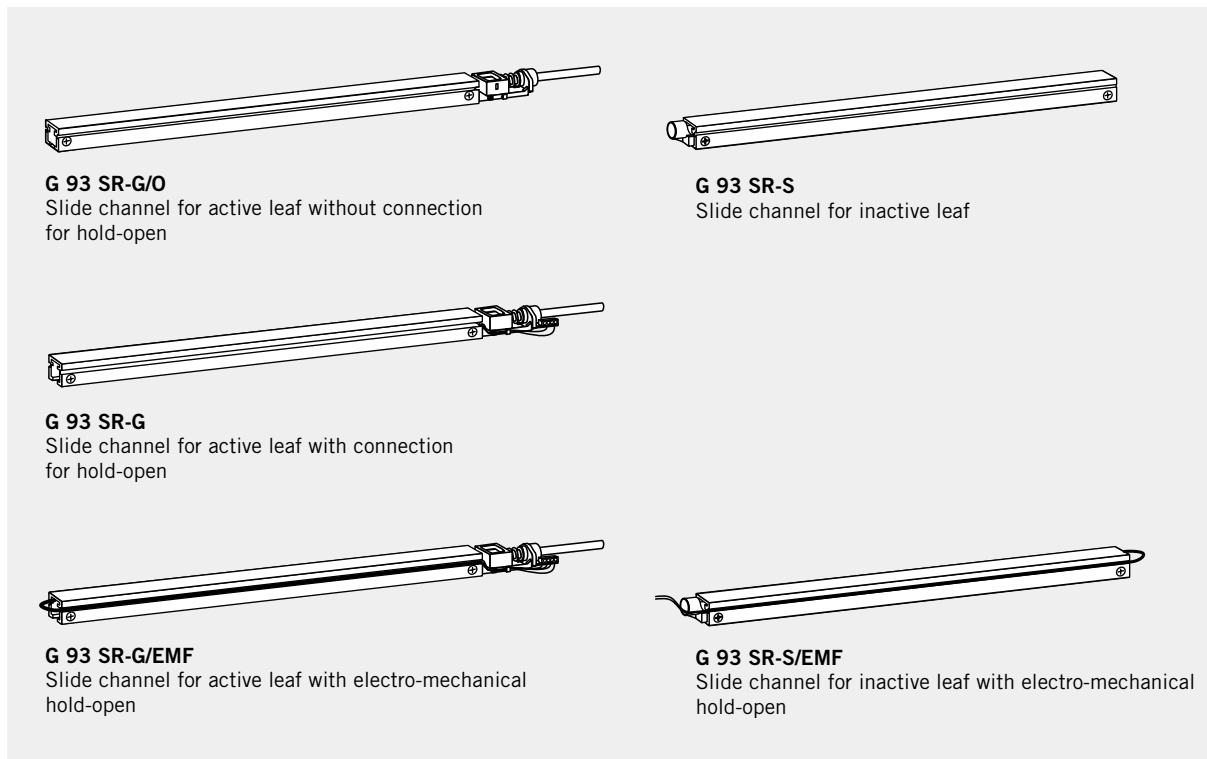
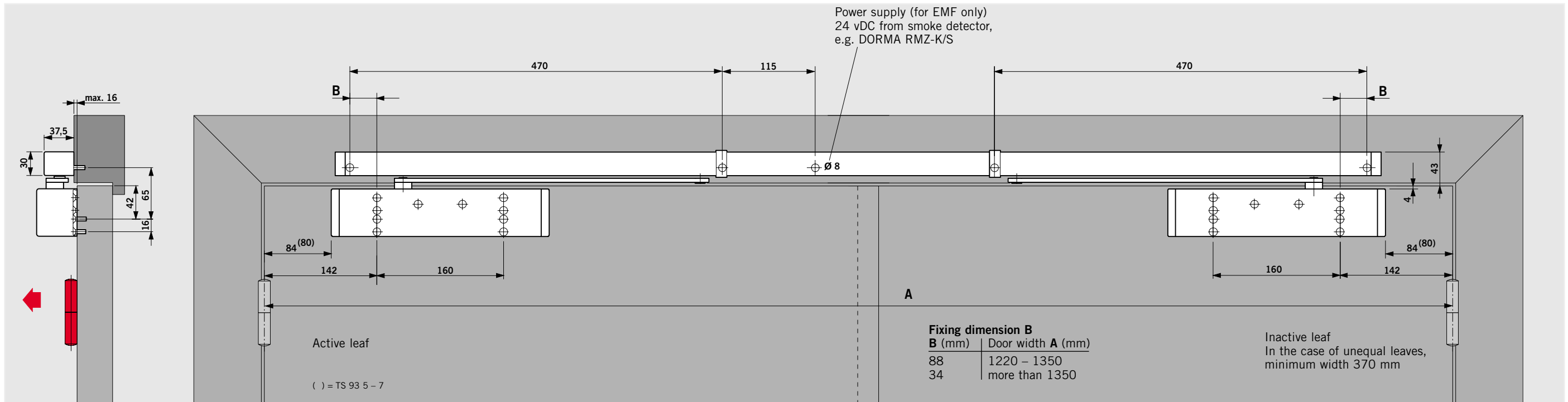

A DORMA G 93 GSR door co-ordinator slide channel generally comprises the following: Active leaf slide channel, inactive leaf slide channel and cover set with slide arms and connection tube.

Model/Function	Door width A (mm)	TS 93 Closer size	Cover set ¹⁾	Slide channels
GSR Door co-ordinator	1220 – 1350	2 – 5	G 93 SR-VK ²⁾	G 93 SR-G/O
	1350 – 2500	2 – 5	G 93 SR-V	G 93 SR-S
	2500 – 3200	5 – 7	G 93 SR-VL	
GSR-EMF 1 Door co-ordinator and hold-open of the inactive leaf	1220 – 1350	2 – 5	G 93 SR-VK ²⁾	G 93 SR-G
	1350 – 2500	2 – 5	G 93 SR-V	G 93 SR-S/EMF
	2500 – 3200 ³⁾	5 – 7	G 93 SR-VL	
GSR-EMF 2 Door co-ordinator and hold-open of both leaves	1220 – 1350	2 – 5	G 93 SR-VK ²⁾	G 93 SR-G/EMF
	1350 – 2500	2 – 5	G 93 SR-V	G 93 SR-S/EMF
	2500 – 3200 ³⁾	5 – 7	G 93 SR-VL	
GSR-EMF 1G Door co-ordinator and hold-open of the active leaf	1220 – 1350	2 – 5	G 93 SR-VK ²⁾	G 93 SR-G/EMF
	1350 – 2500	2 – 5	G 93 SR-V	G 93 SR-S
	2500 – 3200 ³⁾	5 – 7	G 93 SR-VL	

1) The covers should be cut to length on site where they meet in the middle, to suit the door size.

2) With short slide arms, 320 mm long.

3) In the case of particularly large and heavy doors (over 2500 mm), we recommend that DORMA EM hold-open magnets be employed instead of the electro-mechanical hold-open unit.

Regulations/Information

The use of hold-open devices may be subject to certain conditions – see page 27.

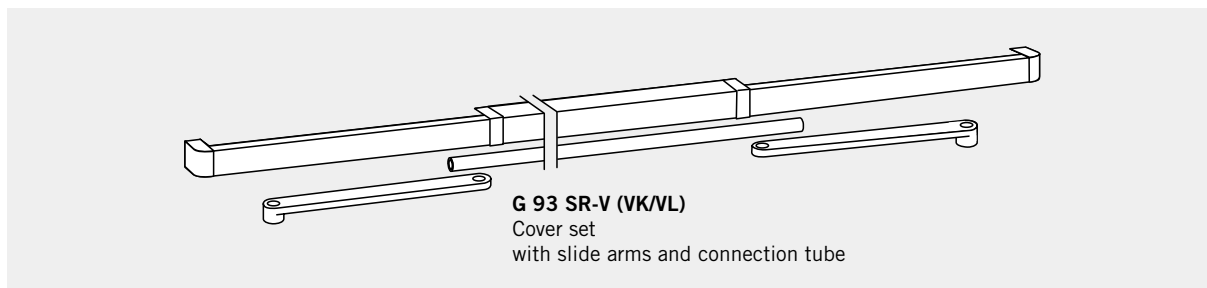

For push-side fixing

The DORMA G 93 GSR/BG slide channel with integral door co-ordinator for **double doors** ensures that the active leaf always closes after the inactive leaf (max. door opening angle 120°; door stop to be positioned accordingly).

A slide channel with an integral door co-ordinator of this system design always consists of an active leaf slide channel, an inactive leaf slide channel and a set of covers.

Not suitable for emergency exit doors which are opened at the inactive leaf.

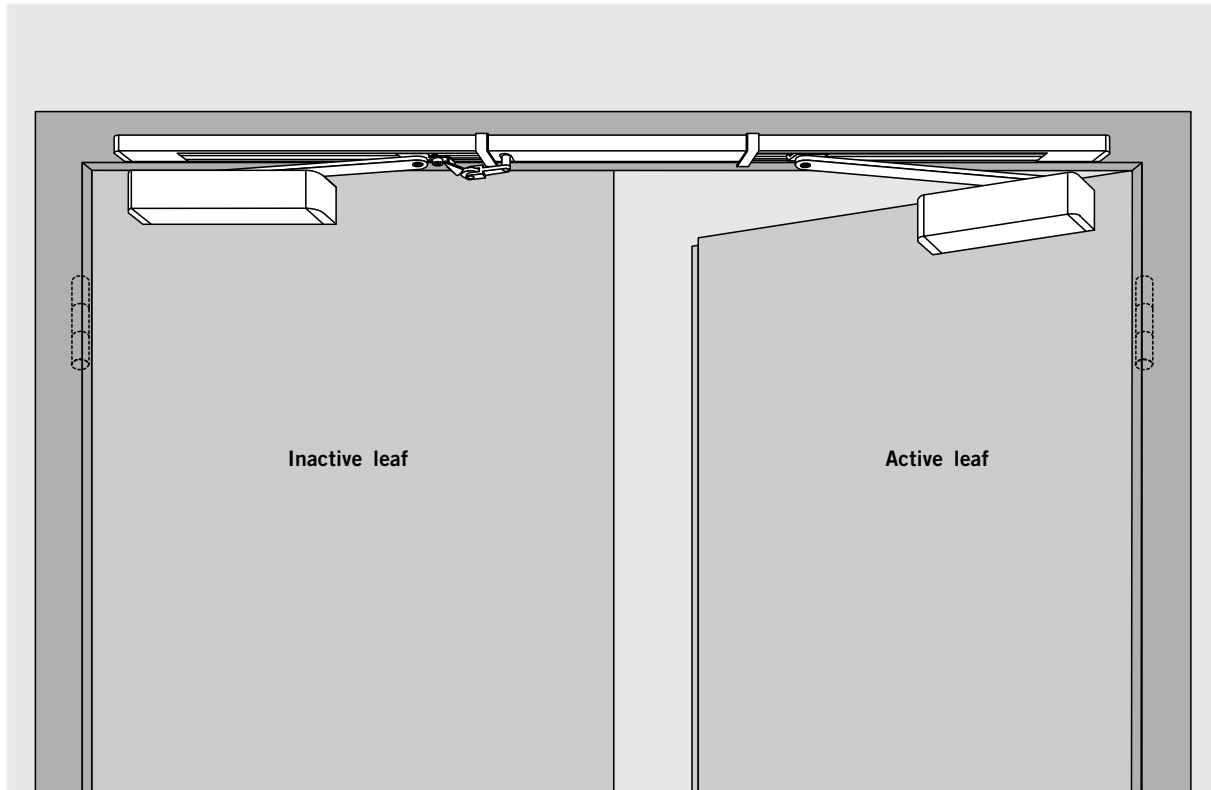

DORMA G 93 GSR/BG

The DORMA G 93 GSR/BG door co-ordinator slide channel features a push rod clamping system. As this system operates independently of the door closer hydraulics, it offers maximum safety and reliability (doors prevented from "creeping closed"). An overload release protects both the door co-ordinator and the door set from damage. The DORMA TS 93 GSR/BG is a handed system with ISO 5 and ISO 6 models, and can be combined with TS 93 G door closers.

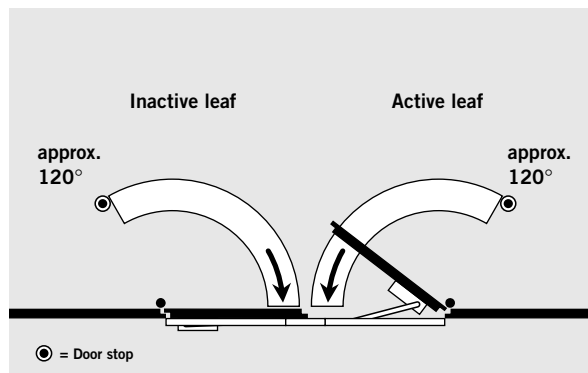

F Approval certification

The DORMA TS 93 GSR/BG has been successfully type-tested to EN 1158, Door Co-ordinator Devices. Certificates are available on request.

Specification text

DORMA TS 93 G door closer (see page 7) with G 93 GSR/BG slide channel, with integral mechanical door co-ordinator employing a push rod clamping system with overload release, which operates independently of the closer hydraulics. With single cover extending over the top of both door leaves. For push-side fixing.

Colour

silver dark brown
white,
like RAL 9010 9016
 stainless steel
 polished brass
 special colour_(like RAL_)

Make

DORMA TS 93 GSR/BG

 TS93GSR/BG/2-5

With integral electro-mechanical hold-open, for push-side fixing

These door co-ordinators not only ensure the correct closing sequence of double doors, but also allow the door leaves to be individually held open in various combinations depending on the slide channel type employed (see page 20). In the event of an alarm or a

fault in the power supply, the hold-open is released and the door is closed by the door closer. The release is triggered by a signal from external smoke detectors (e.g. DORMA RMZ-K/S or DORMA RM). The release force for the hold-open mechanism can

be adjusted without tools and is rated to ensure that the door can also be effortlessly released manually. DORMA G 93 GSR-EMF/BG door co-ordinator slide channels are non-handed and are combined with DORMA TS 93 G door closers.

Specification text

DORMA TS 93 G door closer (see page 7) with G 93 GSR/BG slide channel, with integral mechanical door co-ordinator employing a push rod clamping system with overload release, which operates independently of the closer hydraulics. With single cover extending over the top of both door leaves. For push-side fixing.

DORMA G 93 GSR-EMF 1/BG

This door co-ordinator contains just one hold-open mechanism, located in the inactive leaf slide channel, for holding open both door leaves. The single-point hold-open position is adjustable between approx. 80° and 120°.

Note The active leaf can be opened up to the maximum selected hold-open point (door stop to be positioned accordingly). The active leaf can be held open by the door co-ordinator at any angle up to max. 120°.

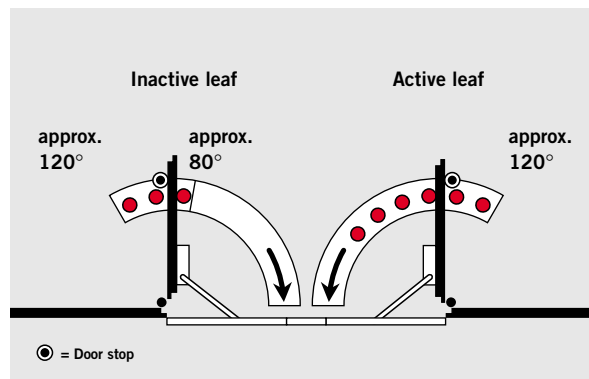

EMF 1/BG

With integrated electro-mechanical hold-open for the inactive leaf, 24 vDC, tested to EN 1155. Hold-open point (80° – 120°) and release force adjustable.

Make

DORMA TS 93 GSR-EMF 1/BG
 TS93GSR-EMF1/BG/2-5

DORMA G 93 GSR-EMF 2/BG

With this door co-ordinator, the active leaf can be held open independently of the inactive leaf. The hold-open points for each leaf lie between approx. 80° and 120°.

Note The active leaf can be opened up to the maximum selected hold-open point (door stop to be positioned accordingly).

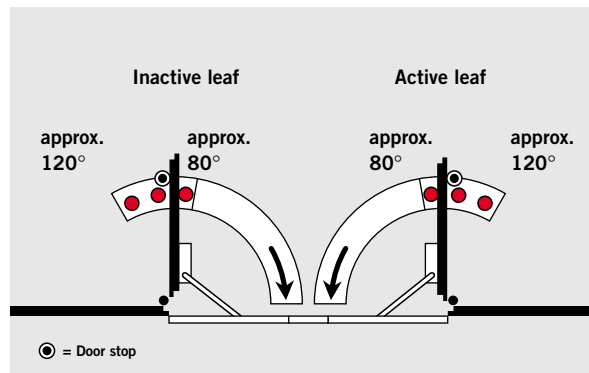

EMF 2/BG

With integrated electro-mechanical hold-open for both leaves, 24 vDC, tested to EN 1155. Hold-open point (80° – 120°) and release force adjustable.

Make

DORMA TS 93 GSR-EMF 2/BG
 TS93GSR-EMF2/BG/2-5

DORMA G 93 GSR-EMF 1G/BG

This door co-ordinator enables the active leaf to be held open independently in special door sets involving, for example, fixed side screens, narrow inactive leaves (asymmetrical double doors), etc. The hold-open point lies between approx. 80° and 120°.

Note The active leaf can be opened up to the maximum selected hold-open point (door stop to be positioned accordingly).

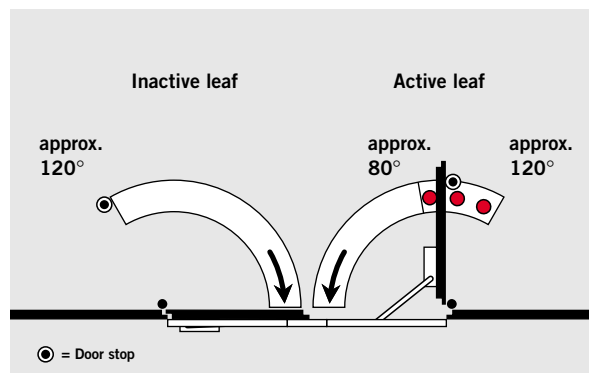

EMF 1G/BG

With integrated electro-mechanical hold-open for the active leaf, 24 vDC, tested to EN 1155. Hold-open point (80° – 120°) and release force adjustable.

Make

DORMA TS 93 GSR-EMF 1G/BG
 TS93GSR-EMF1G/BG/2-5

F Approval certification

The DORMA TS 93 GSR-EMF 1/BG, EMF 2/BG and EMF 1G/BG have been successfully type-tested to EN 1155, Electrically Powered Hold-Open Devices. Certificates are available on request.

Technical data

Operating voltage	24 vDC ± 15%
Power input	1.4 W (GSR EMF 2/BG = 2.8 W)
Rated for continuous duty	100%
Release torque/force	adjustable

Colour

- silver dark brown
- white,
- like RAL 9010 9016
- stainless steel
- polished brass
- special colour_(like RAL_)

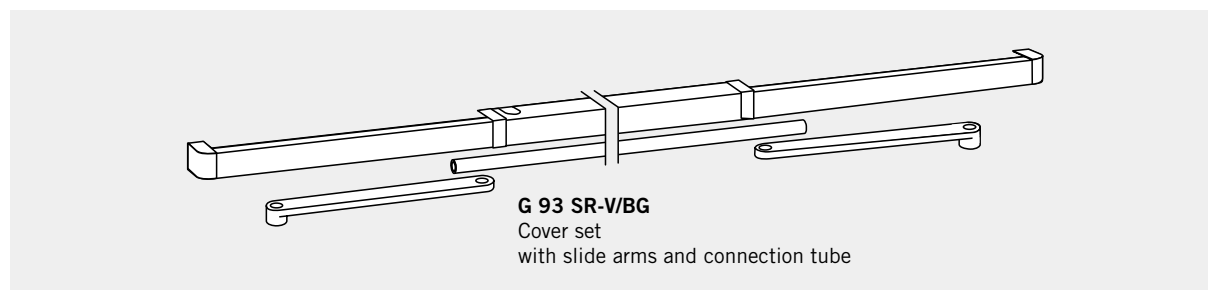
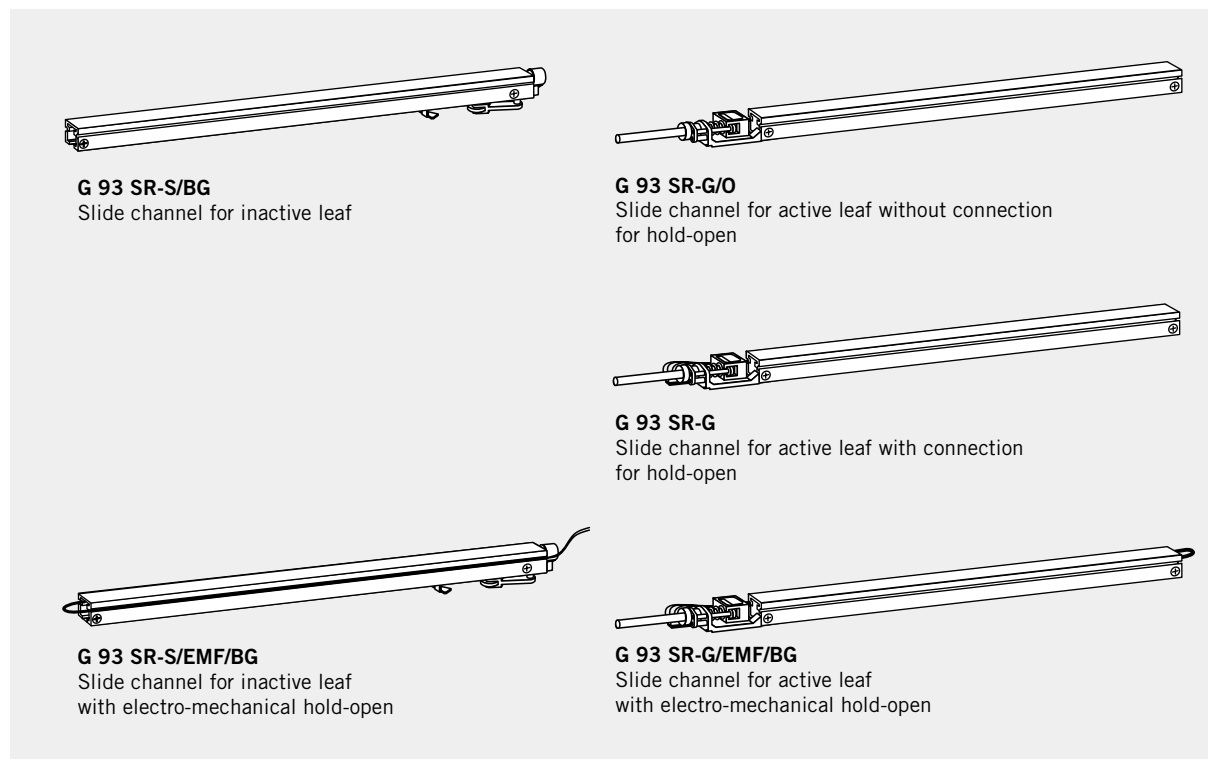
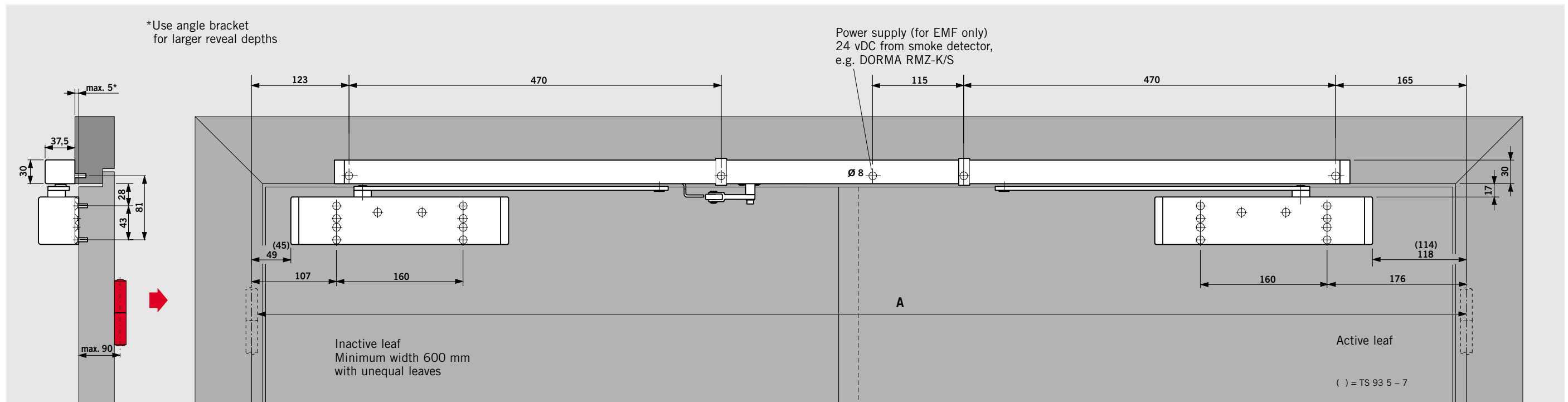

A DORMA G 93 GSR/BG door co-ordinator slide channel generally comprises the following: Active leaf slide channel, inactive leaf slide channel and cover set with slide arms and connection tube.

Model/Function	Door width A (mm)	TS 93 Closer size	Cover set ¹⁾	Slide channels
GSR/BG Door co-ordinator	1500 – 2500	2 – 5	G 93 SR-V/BG	G 93 SR-G/O G 93 SR-S/BG
GSR-EMF 1/BG* Door co-ordinator and hold-open of the inactive leaf	1500 – 2500 ²⁾	2 – 5	G 93 SR-V/BG	G 93 SR-G G 93 SR-S/EMF/BG
GSR-EMF 2/BG* Door co-ordinator and hold-open of both leaves	1500 – 2500 ²⁾	2 – 5	G 93 SR-V/BG	G 93 SR-G/EMF/BG G 93 SR-S/EMF/BG
GSR-EMF 1G/BG* Door co-ordinator and hold-open of the active leaf	1500 – 2500 ²⁾	2 – 5	G 93 SR-V/BG	G 93 SR-G/EMF/BG G 93 SR-S/BG

¹⁾ The covers should be cut to length on site where the ends meet in the middle, to suit the door size.

²⁾ In the case of particularly large and heavy doors, we recommend that DORMA EM hold-open magnets be employed instead of the electro-mechanical hold-open unit.

* Planned availability from spring 1999

Regulations/Information

The use of hold-open devices may be subject to certain conditions – see page 27.

The DORMA RMZ-K/S frame-mounted smoke detector and the DORMA RM frame and ceiling-mounted smoke detector provide the ideal complement to the successful, service-proven DORMA TS 93 range of preventive fire protection products. They are designed in accordance with the latest codes issued by the German Institute for Building Technology, and ensure perfect interaction between all the devices employed for holding open fire and smoke doors – whatever the situation.

The innovative design of these devices has ensured a high degree of compactness so that there are no installation or positioning problems. And their attractive Softline styling blends in with any surroundings.

F Approval certification

DORMA RMZ-K/S and DORMA RM units have been approved by the German Institute for Building Technology, Berlin, as hold-open release devices.

DORMA RMZ-K/S

Frame-mounted smoke detector with stabilised power supply unit. This detector is available as an Enhanced or Standard model.

In the event of an alarm or a power failure, this unit de-energises all the hold-open devices connected to it (release function).

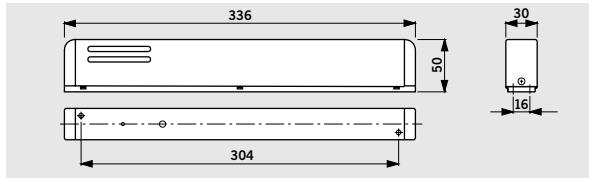

DORMA RM

Designed as a smoke switch; actuates a floating (volt-free) change-over contact in the event of an alarm or power failure. Also suitable as an

add-on smoke detector for the DORMA TS 73 EMR, TS 93 EMR and RMZ.

Tested by VdS Cologne to EN 54, Part 7.

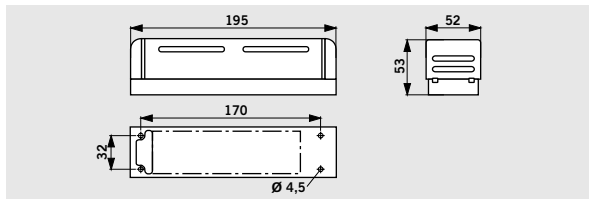

Specification texts

RMZ-K/S

Smoke detector for frame mounting with integrated power supply unit and optical smoke sensor. For release of DORMA hold-open devices. With connections for further smoke detectors. Floating (volt-free) change-over contact and connection terminals for external manual release. Input voltage 230 vAC. Operating voltage 24 vDC. Approved by the Institute for Building Technology in Berlin as a hold-open release device.

Colour

- silver dark brown
- white, like RAL 9010 9016
- stainless steel
- polished brass
- special colour_(like RAL_)

Model

- Enhanced model with optional connection of additional detectors, external manual release and floating (volt-free) alarm contact. **Make DORMA RMZ-K**
- Standard model with optional connection of additional 2-wire detectors **Make DORMA RMZ-S**



Data and features		RMZ-K	RMZ-S	RM
Functions	Smoke detector Release device Power supply unit	● ● ●	● ● ●	● ● –
Smoke detection	Scattered light principle (optical sensor)	●	●	●
Fixing	Frame-mounted Ceiling-mounted	● –	● –	● ●
Connection of other detectors	2-wire smoke switches	● ●	● –	● ●
Total installed load (max.) for hold-open device and other detectors in W		4.4	4.4	Depends on power supply unit
Power input of internal detectors in W		0.5	0.5	0.6
Indicators	Alarm – red LED Armed – green LED	● ●	● ●	● ●
Input voltage		230 V AC ± 10 %	230 V AC ± 10 %	24 V DC +15%, -10%
Output voltage		24 V DC	24 V DC	24 V DC
Detector operating voltage		24 V DC	24 V DC	24 V DC +15%, -10%
Input current (max.) with external power supply unit, in A		–	–	2
Current input (max.) in mA		111	91	25
Floating change-over contact	Switching voltage (max.) Switching current (max.) Switching capacity (max.)	60 V DC/ 25 V AC 2 A 60 W	–	60 V DC/ 25 V AC 2 A 60 W
Automatic reset, can be changed to manual reset		● –	● –	● ●
Test port for functional checking		●	●	●
Connection terminals for external manual release		●	–	●
Degree of protection		IP 20	IP 20	IP 20
Ambient temperature in °C		–15, +60	–15, +60	–20, +50
Weight in kg		0.6	0.6	0.4
Dimensions in mm	Length Overall depth Height	336 50 30	336 50 30	195 53 52

● yes – no

For more detailed information, see RMZ/RM brochure

RM

Non-directional, universal optical smoke detector (24 vDC) for frame and ceiling installation. Can be employed as smoke switch and monitoring device for hold-open devices. With connections for further smoke detectors, floating (volt-free) change-over contact and connection terminals for external manual release. Approved by the Institute for Building Technology, Berlin for general use as a hold-open release device and tested by the VdS Cologne to EN 54 Part 7.

Colour

- silver dark brown
- white, like RAL 9010 9016
- stainless steel
- polished brass
- special colour_(like RAL_)



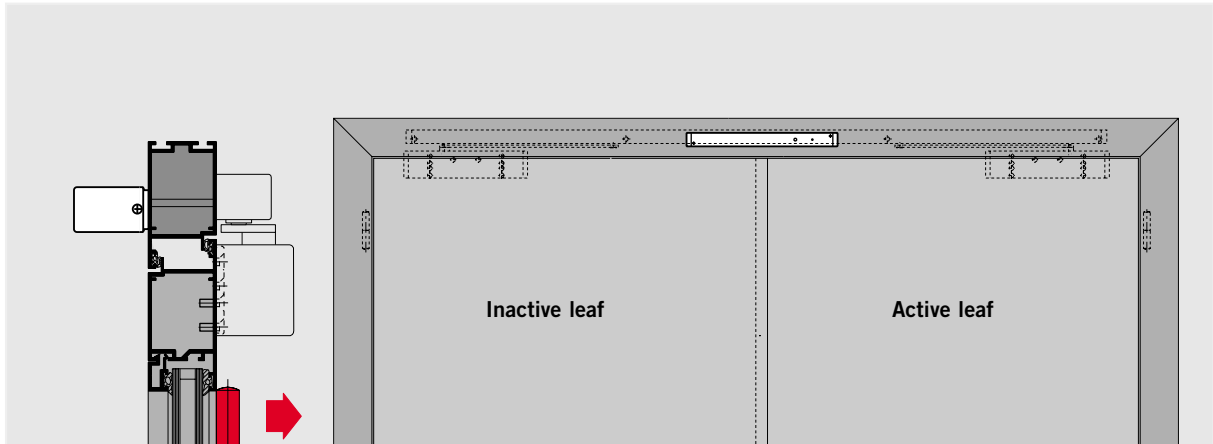

RMZ-K/S frame-mounted smoke detector on the push side
connected to a G 93 GSR on the pull side

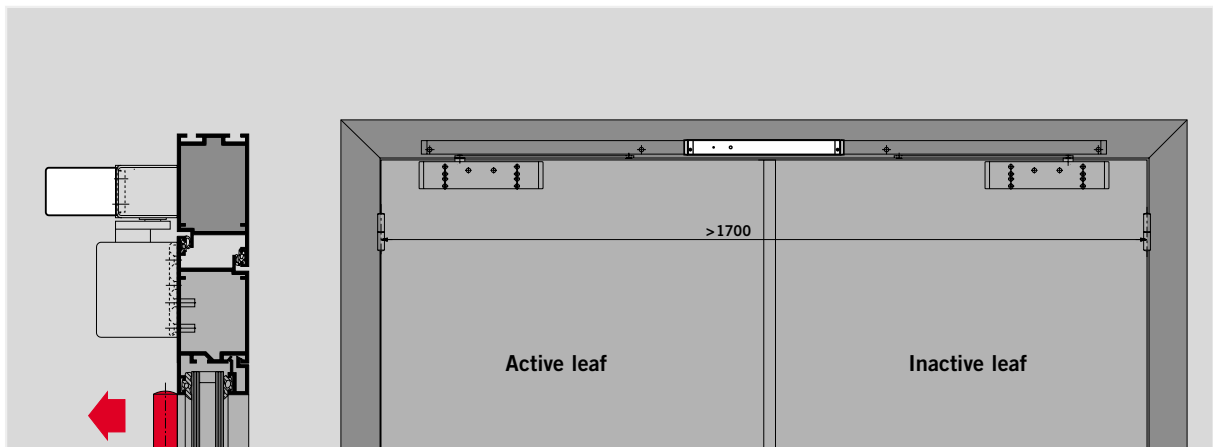

RMZ-K/S frame-mounted smoke detector on the pull side
connected to a G 93 GSR on the pull side (use mounting bracket)

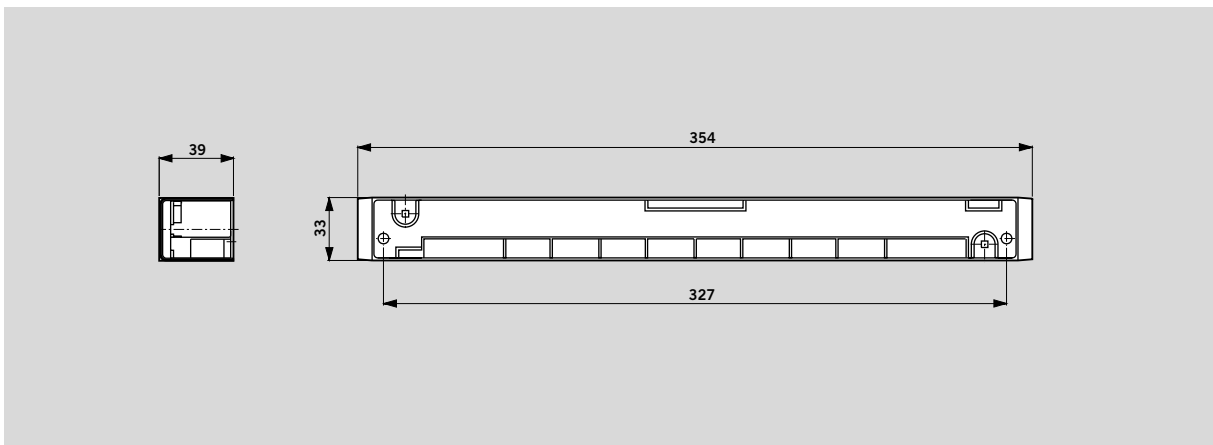

Mounting bracket for RMZ-K/S frame-mounted smoke detector

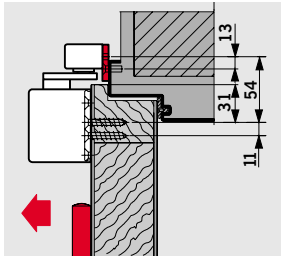

30 mm mounting backplate for G 93 N

For fixing the slide channel to the door frame where direct fixing is not possible.

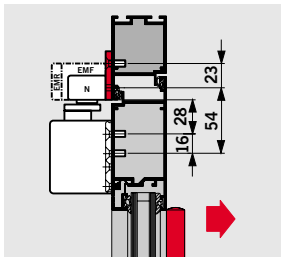
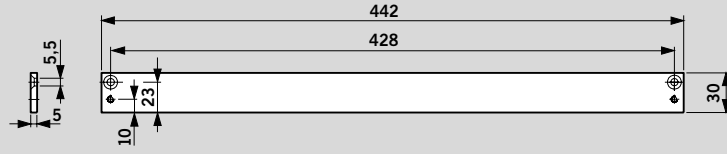

40 mm mounting backplate for G 93 N, EMF, EMR

For fixing the slide channel to the door frame where direct fixing is not possible.

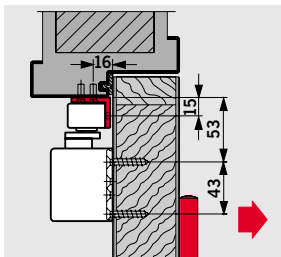
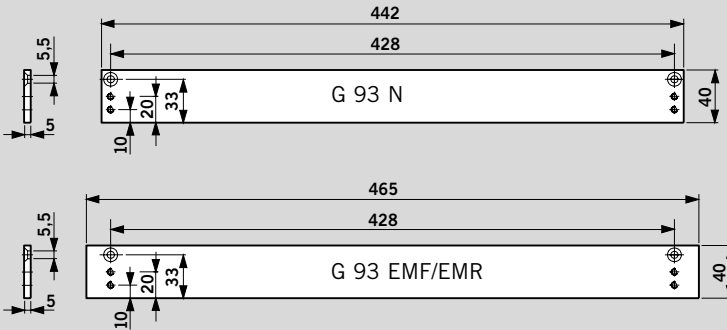

Angle bracket for G 93 N

For push-side fixing of the slide channel to door frames with a deep reveal.

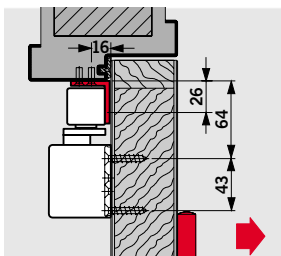
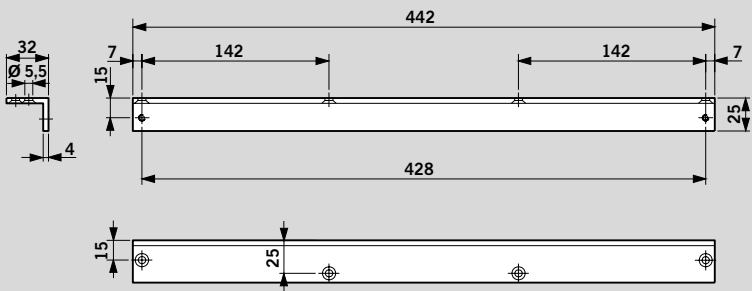

Angle bracket for G 93 EMF

For push-side fixing of the slide channel to door frames with a deep reveal.

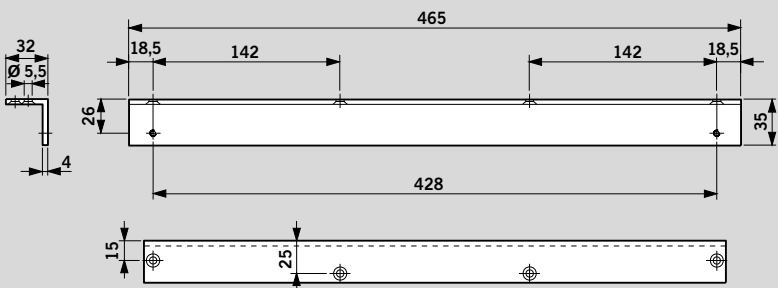

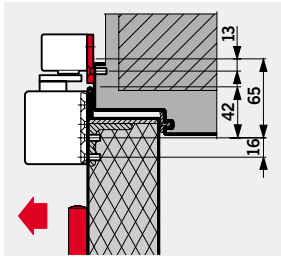

40 mm mounting backplate for G 93 GSR

For fixing the slide channels to the door frame where direct fixing is not possible.

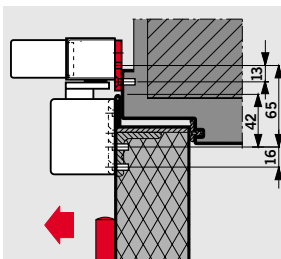
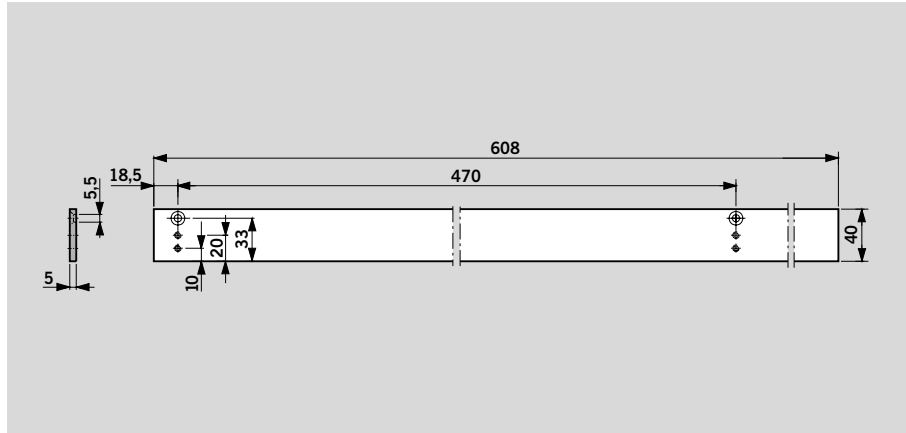

40 mm mounting backplate for RMZ-K/S base unit in conjunction with a G 93 GSR
(also as filler between the two G 93 GSR mounting backplates)

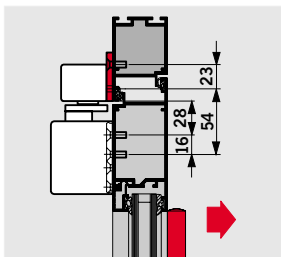
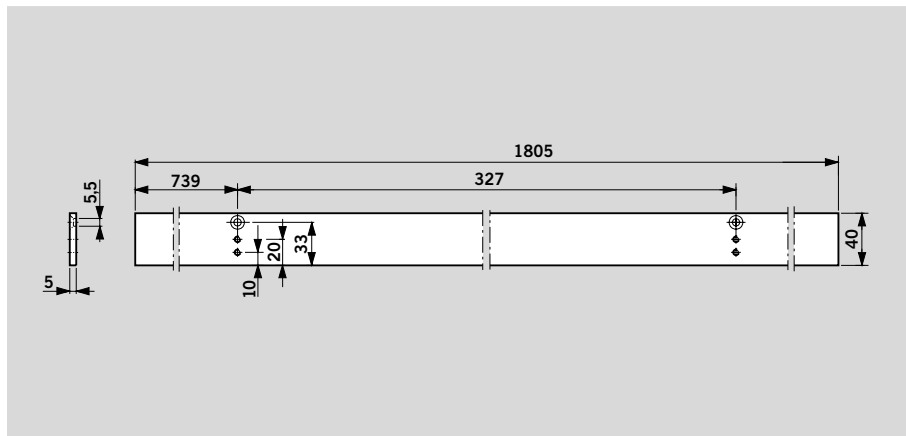

40 mm mounting backplate for G 93 GSR/BG

For fixing the slide channels to the door frame where direct fixing is not possible.

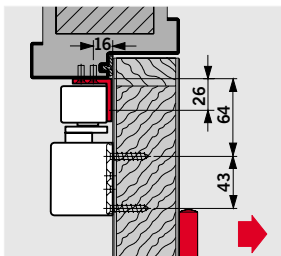
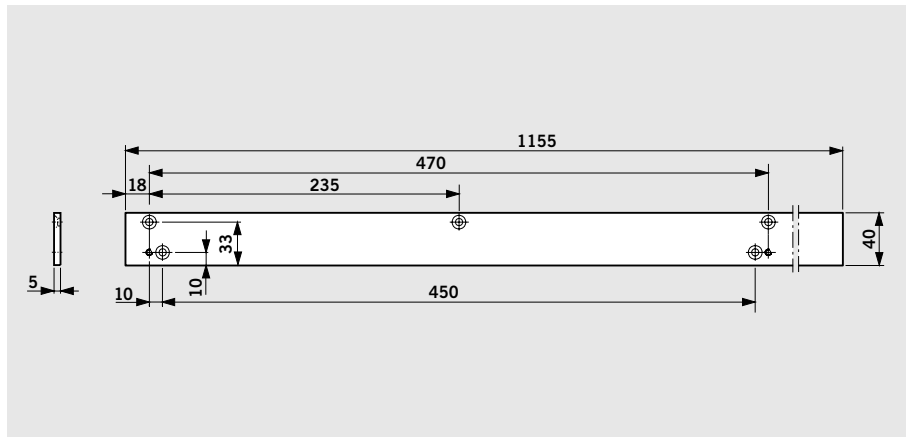

Angle bracket for G 93 GSR/BG

For fixing the slide channels to door frames with a deep reveal.

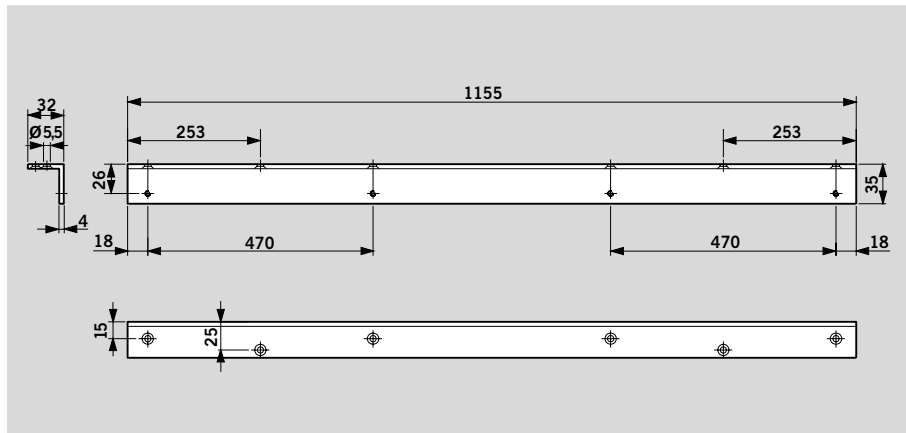

If the DORMA GSR door co-ordinator is to operate independently of the TS 93 door closer, for example, in combination with the ED 200 automatic swing door operator, the connection between the door co-ordinator and the door leaf is provided by means of GSR pivot blocks.

F Approval certification

The DORMA GSR door co-ordinator with pivot blocks has been approved by e.g. the State Material Testing Authority, Dortmund/Germany, for use on double fire and smoke doors.

Specification text

Pivot blocks for closer-independent door co-ordination with DORMA G 93 GSR door co-ordinators.

Colour

silver dark brown
 white, like RAL 9010 9016
 special colour_(like RAL_)

Make

DORMA GSR pivot block

 GSR

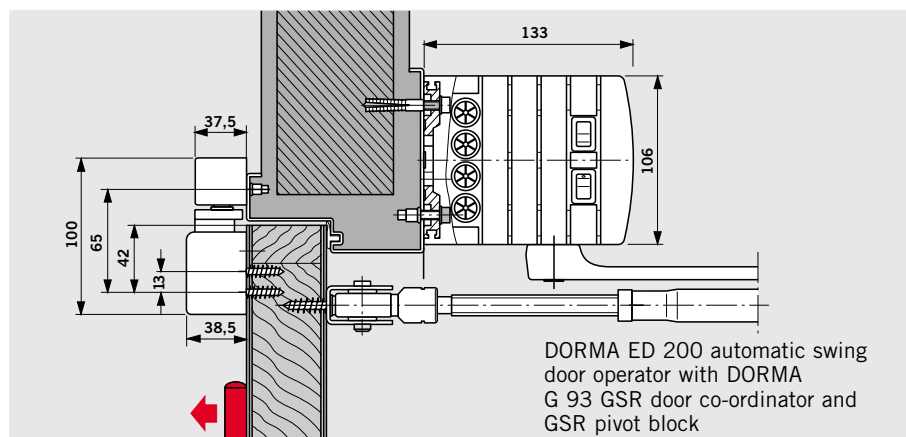
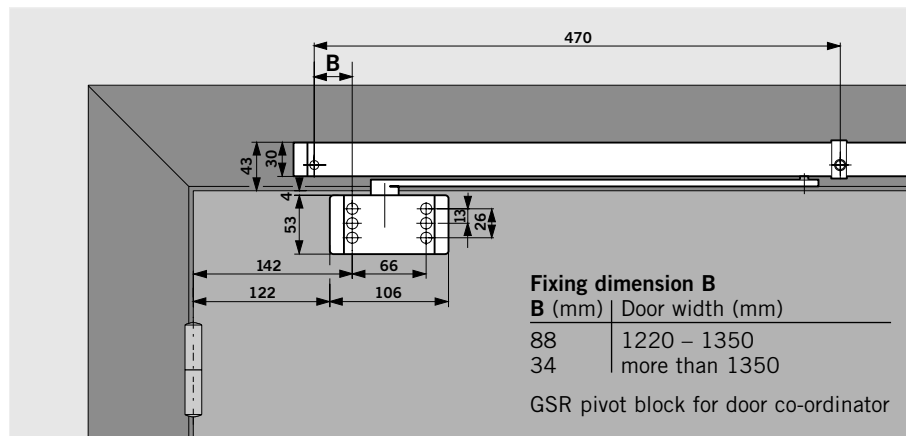

The use of hold-open devices may be subject to certain conditions. These usually deal particularly with the relevant acceptance, routine inspection and maintenance requirements.

The information given on this page is designed to inform all relevant persons of the most important measures to be implemented in order to ensure best practice governing the operation of hold-open systems.

Further details can be found in the following documents:

- Guidelines for hold-open systems, published by the German Institute for Building Technology, Berlin.
- Building Regulations, England and Wales
- Relevant regulations for Scotland and N. Ireland
- EN 1155

1 General

1.1 In respect of doors etc. which are held open by hold-open systems, the area needed for closure must be kept permanently free of obstructions. This area should be clearly indicated by means of lettering, floor markings or similar. If necessary, structural measures may need to be taken in order to ensure that wiring/ducting, stored goods or structural components (e.g. false ceilings or other components) do not fall down into the area to be kept clear.

1.2 As far as possible, smoke detectors should be used for hold-open systems. Smoke detectors should be used for hold-open systems for doors etc. in emergency exits and escape routes.

1.3 All hold-open devices should be able to be released manually without their operational readiness being adversely affected. Door closers with electro-magnetic hold-open systems can be released by pressing lightly on the door leaf. If hold-open magnets or free-swing door closers are used, the release function is triggered by pressing a switch. The switch must be located in the immediate proximity of the door and must not be covered when the door is held open.

2 Commissioning











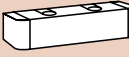
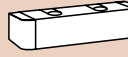



2.1 After the system has been fitted ready for use on-site, it should be commissioned to check that its operation is problem-free and that its installation complies with all relevant regulations. The commissioning should only be performed by qualified technical personnel.



3 Routine inspection

3.1 The operator should keep the hold-open system in a permanently fit state for use and must inspect it at least once a month to ensure its functional integrity.

3.2 In addition, it is the responsibility of the operator to ensure that all devices are checked and maintained/serviced to ensure their combined functional integrity, this to be performed at least once a year, unless a shorter time period is stipulated in the national regulations. This inspection and servicing activity should only be carried out by a specialist or suitably qualified person.

3.3 The scope, result and time of the routine inspections should be recorded, and these records should be retained by the operator.

		TS 93 B	TS 93 G	30 mm mounting backplate for G 93 N	40 mm mounting backplate for G 93 N
		 EN 2 – 5 ■ 120200xx EN 5 – 7 ■ 125200xx	 EN 2 – 5 ■ 120300xx EN 5 – 7 ■ 125300xx	 183400xx	 183500xx
For specification text/product description, see page		6	7	24	24
G 93 N  □ 180100xx	8			#	#
G 93 EMF  □ 180300xx	10				
G 93 EMR-K  □ 180408xx	12				
G 93 EMR-S  □ 180407xx	12				

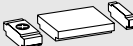
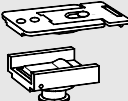
40 mm mounting backplate for G 93 EMF, EMR	Angle bracket for G 93 N	Angle bracket for G 93 EMF	Cushioned limit stay set for G 93 N	Add-on hold-open unit for G 93 N
 182900xx	 183600xx	 183000xx	 35800093	 18260000
24	24	24	8	8
	#		#	#
#		#		
#				
#				

Smoke detector system

RMZ-K
180619xx



RMZ-S
180618xx

RM
3570xx88

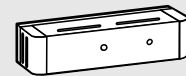

For specification text/product description, see page 22











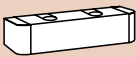
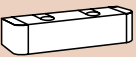



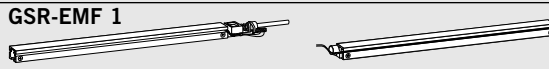



- = Closer separate
- = Slide channel assembly separate
- # = Optional accessory





Colour xx

Silver	01
Dark brown	03
White (like RAL 9016)	11
White (like RAL 9010)	10
Special colour	09

Also available in matching "Design" finishes: Stainless steel 04
Polished brass 05

"Design" refers to the surface finish of the products

A door co-ordinator slide channel assembly of this system design always comprises an active leaf slide channel, an inactive leaf slide channel and a set of covers.			 TS 93 B EN 2 – 5 ■ 120200xx ¹⁾ EN 5 – 7 ■ 125200xx ¹⁾	 TS 93 G EN 2 – 5 ■ 120300xx ¹⁾ EN 5 – 7 ■ 125300xx ¹⁾	 Mounting backplate for GSR 184500xx	 Mounting backplate for GSR/BG 183100xx
For specification text/product description, see page			6	7	25	25
GSR  G 93 SR-G/0 X 18400000	 G 93 SR-S X 18430000	14	X	2x ■	#	
GSR-EMF 1  G 93 SR-G X 18410000	 G 93 SR-S/EMF X 18440000	15	X	2x ■	#	
GSR-EMF 2  G 93 SR-G/EMF X 18420000	 G 93 SR-S/EMF X 18440000	15	X	2x ■	#	
GSR-EMF 1G  G 93 SR-G/EMF X 18420000	 G 93 SR-S X 18430000	15	X	2x ■	#	
GSR/BG  G 93 SR-G/0 X 18400000	 G 93 SR-S/BG X 18170000	18		X	2x ■	#
GSR-EMF 1/BG  G 93 SR-G X 18410000	 G 93 SR-S/EMF/BG X 18180000	19		X	2x ■	#
GSR-EMF 2/BG  G 93 SR-G/EMF/BG X 18200000	 G 93 SR-S/EMF/BG X 18180000	19		X	2x ■	#
GSR-EMF 1G/BG  G 93 SR-G/EMF/BG X 18200000	 G 93 SR-S/BG X 18170000	19		X	2x ■	#

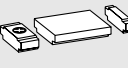
Angle bracket for GSR/BG	RMZ-K/S base unit	Mounting back-plate for RMZ-K/S base unit	Pivot block	Cushioned limit stay
				
183200xx	180700xx ¹⁾	184600xx	3590xx07	18020000
25	23	25	26	8
			#	#
	#	#		
	#	#		
	#	#		
#			#	#
#				
#				
#				

Smoke detector system

RMZ-K
180619xx¹⁾



RMZ-S
180618xx¹⁾

RM
3570xx88¹⁾

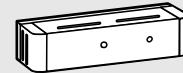

For specification text/product description, see page 22

Cover sets with arms

GSR

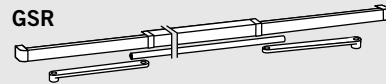

Door width mm	Cover set	Order No.
1220–1350	G 93 SR-VK ²⁾	182110xx ¹⁾
1350–2500	G 93 SR-V	182111xx ¹⁾
2500–3200	G 93 SR-VL	182112xx ¹⁾

²⁾With short slide arms, 320 mm long

GSR/BG

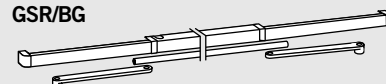

Door width mm	Cover set	Order No.
1500–2500	G 93 SR-V/BG	182200xx ¹⁾

- = Closer separate
- = Slide channel assembly separate
- # = Optional accessory

Colour xx

Silver	01
Dark brown	03
White (like RAL 9016)	11
White (like RAL 9010)	10
Special colour	09

¹⁾ Also available in matching "Design" finishes: Stainless steel 04 Polished brass 05

"Design" refers to the surface finish of the products

DORMA Door Controls Ltd

DORMA Trading Park
Staffa Road
GB-London E10 7QX
Tel. 020 8558 8411
Fax 020 8558 6122
Email: hardware@dorma-uk.co.uk

DORMA Door Controls Ltd

19 Sandyford Office Park
Foxrock
IRL-Dublin 18
Tel. 01 295 8280/1/2
Fax 01 295 8584
Email: dormadublin@dorma.com

DORMA GmbH + Co. KG

Postfach 4009
D-58247 Ennepetal
Tel. +49 (0) 23 33/793-0
Fax +49 (0) 23 33/79 34 95

Internet: www.dorma.com

Subject to change without notice